

Moulding Profiles

Table of Contents

Introduction

Custom Curved Interior Casings

1	Bands & Base Caps	
	Bands 1	1.1
	Base Caps	1.2
2	Casings	
	Back Bands	2.1
	Casings	2.2
3	Bases	
4	Crowns	
5	HandRails	
6	Chair Rails	
7	Cap Mouldings	
8	Beads	
9	Paneling	
10	Fluting	
11	Plinth Block	
12	Rounds	
13	Scotias & Nosing	
14	Plows & Rabbits	
15	Angles, Thresholds, Reducers	
16	Sills & Stools	
17	Miscellaneous	

Custom Moulding Profile Catalog

The cutters for the profiles in this catalog are available to mill custom moulding, in your choice of wood species. We have a large selection of hardwood and softwood available in stock or we can special order most commercial species.

Many profiles can be altered for thickness or width. If you do not see what you need, please inquire. Custom cutter grinding is available. A full dimension drawing or sample is required.

Maximum depth of cut is $\frac{3}{4}$ "; Maximum width is 7"

Half round casings and circle segments require a radius or diameter, including reveal

Elliptical and odd shapes require templates

Templates should be made from rigid stock such as $\frac{1}{4}$ " mdf or masonite

See next page for measuring instructions

To obtain a quote please provide:

- Profile #
- Species of Wood
- Quantity
- Thickness & Width (if not standard)
- Special Instructions

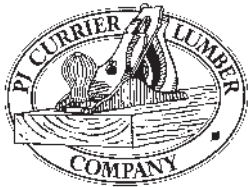

PJ Currier Lumber Inc.

Lumberyard:

Rte 122
Amherst, NH 03031
Tel (603) 673-1913
Fax (603) 672-1148
www.pjclbr.com

Office & Mailing Address:

48 Rte 101A
Amherst, NH 03031
Tel (603) 673-3130
Fax (603) 673-1289

Full Circle

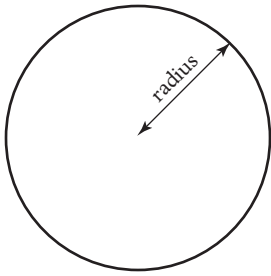

1/2 Round

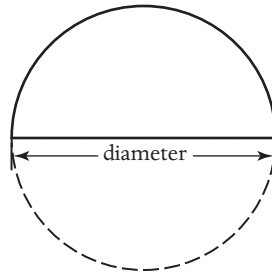

1/4 Round

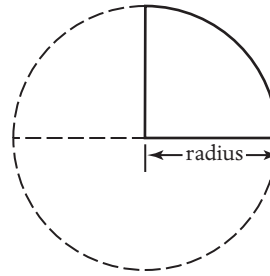

To measure for casing of a true radius window:

A true radius means that the arc is part of a circle. Measure inside diameter or radius of circle (specify). Add 1/2" to diameter for casing reveal (1/4" each side).

Eyebrow

Height is less than half the width

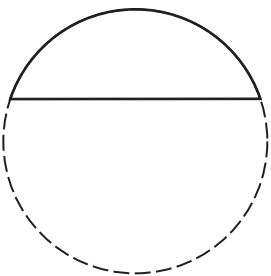

Eyebrow w/ springline

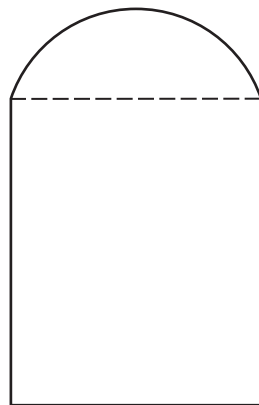

Eyebrow/circle segment

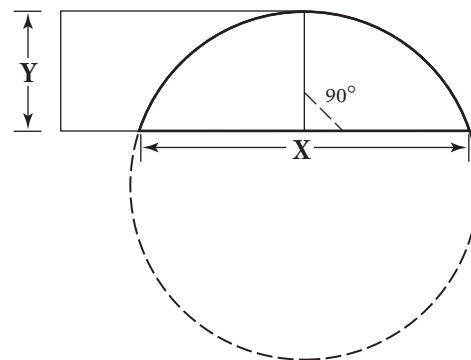

To measure for casing of an eyebrow:

To find "X"—measure inside to inside of jamb at the widest point.

To find "Y"—measure from the center of "X" to top inside of jamb. Make sure you are 90° to the chord "X".

We will calculate the diameter of the circle from these measurements. We will allow for 1/4" reveal on casing unless specified otherwise.

Full Ellipse

Not a true radius

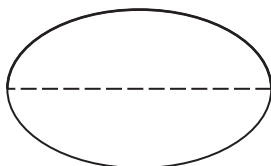

1/2 Ellipse

Not a true radius

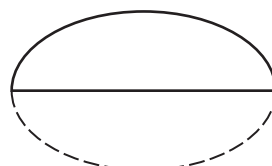

To measure for casing for an elliptical window:

Elliptical casing requires a hard template. Templates should be 1/4" MDF or masonite. Attach sheet to the wall, covering the window. Cut out with router and flush trim bit. Follow inside of curve with ball bearing bit. Paper templates are *not acceptable*, as there is no accurate way to transfer the line to solid material. Consider cutting template before window is installed, especially if it is to be installed up high.

$1\frac{1}{16}'' \times 1\frac{1}{2}''$



PJ100

$1\frac{1}{16}'' \times 1\frac{3}{4}''$



PJ101

$1\frac{1}{16}'' \times 1\frac{1}{2}''$



PJ111

$1\frac{1}{4}'' \times 1\frac{3}{4}''$

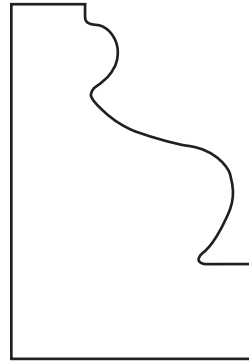

PJ104

$1\frac{3}{16}'' \times 1\frac{3}{4}''$

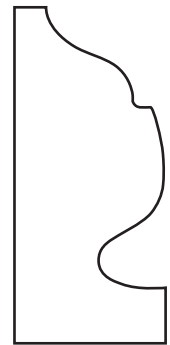

PJ109

$1\frac{1}{16}'' \times 1\frac{1}{8}''$



8462

$1\frac{1}{16}'' \times 1\frac{1}{2}''$

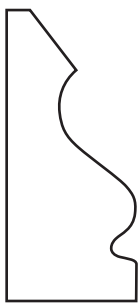

8463

$1\frac{1}{16}'' \times 1\frac{3}{4}''$



8465

$\frac{7}{8}'' \times 1\frac{5}{8}''$

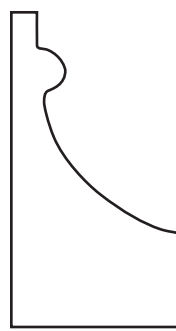

PJ105

$\frac{5}{8}'' \times 1\frac{5}{8}''$



PJ112

$1\frac{1}{16}'' \times 1\frac{3}{4}''$

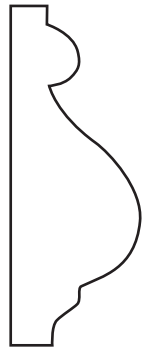

PJ108

$\frac{3}{4}'' \times 3\frac{1}{2}''$



PJ113

$\frac{9}{16}'' \times 1\frac{7}{16}''$



PJ137

$1\frac{1}{16}'' \times 2\frac{1}{2}''$



PJ124

$1\frac{3}{16}'' \times 2''$



PJ110

$\frac{3}{4}'' \times 2\frac{1}{2}''$



PJ117

$\frac{5}{8}$ " x $1\frac{1}{2}$ "

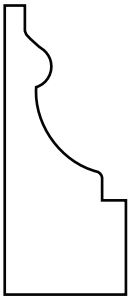

PJ107

$\frac{7}{8}$ " x $1\frac{3}{4}$ "

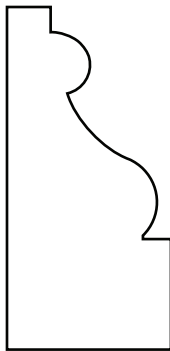

PJ139

$1\frac{1}{8}$ " x 2"

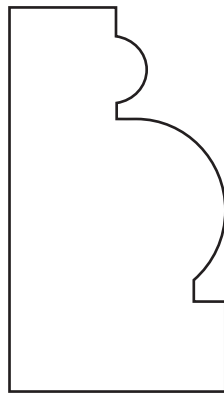

PJ140

$\frac{5}{8}$ " x $1\frac{7}{8}$ "



PJ144

$\frac{7}{16}$ " x $1\frac{3}{8}$ "



PJ148

$1\frac{1}{16}$ " x $1\frac{1}{8}$ "

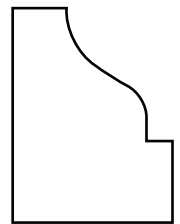

PJ147

$\frac{7}{8}$ " x $1\frac{7}{16}$ "

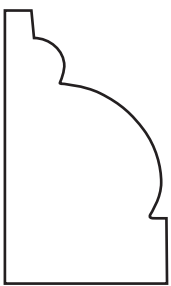

PJ141

1" x H

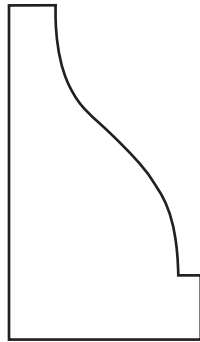

PJ129

$\frac{3}{4}$ " x $1\frac{3}{4}$ "



PJ151

$\frac{3}{4}$ " x 2"



PJ152

$1\frac{1}{8}$ " x $1\frac{3}{4}$ "

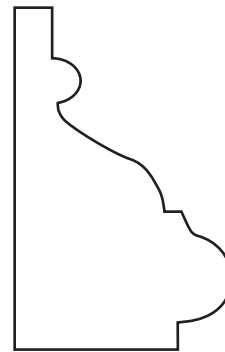

PJ150

$1\frac{1}{16}$ " x $1\frac{1}{2}$ "

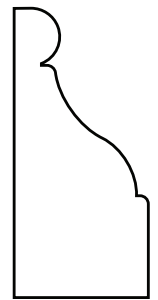

PJ155

$1\frac{1}{4}$ " x $2\frac{1}{2}$ "

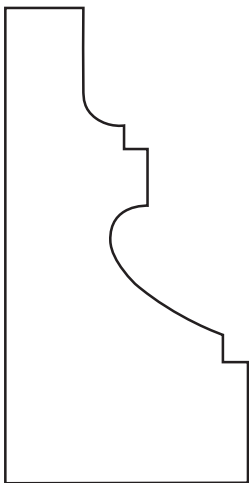

PJ153

$\frac{7}{8}$ " x $2\frac{1}{4}$ "

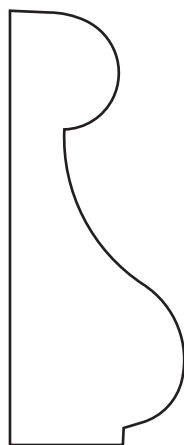

PJ157

$\frac{3}{4}$ " x $2\frac{1}{4}$ "

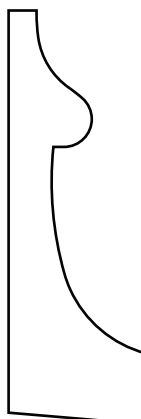

PJ158

$\frac{3}{8}$ " X $\frac{1}{2}$ "?



8575

$\frac{5}{8}$ " X $\frac{7}{8}$ "?



PJ130

$\frac{13}{16}$ " X $1\frac{1}{4}$ "



PJ132

$1\frac{1}{16}$ " X 1"



PJ102

$\frac{3}{4}$ " X $1\frac{3}{8}$ "



PJ127

$\frac{9}{16}$ " X $1\frac{3}{8}$ "



PJ114

$\frac{9}{16}$ " X 1"



PJ136

$\frac{9}{16}$ " X $1\frac{1}{8}$ "



8453

$1\frac{1}{16}$ " X $1\frac{3}{8}$ "



8455

$\frac{3}{4}$ " X $1\frac{5}{8}$ "



PJ133

$1\frac{1}{16}$ " X $1\frac{3}{8}$ "



PJ116

$1\frac{1}{16}$ " X $1\frac{3}{8}$ "

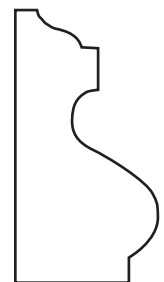

PJ115

$1\frac{1}{16}$ " X $1\frac{5}{8}$ "

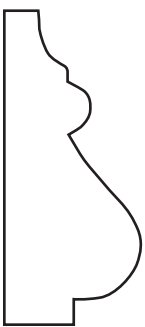

PJ121

$\frac{3}{4}$ " X $1\frac{5}{8}$ "



PJ103

$1\frac{1}{16}$ " X $1\frac{7}{8}$ "



PJ125

$1\frac{1}{16}$ " X $1\frac{3}{4}$ "



PJ126

$\frac{7}{8}$ " X $1\frac{3}{4}$ "



PJ128

$1\frac{3}{16}$ " X $1\frac{3}{4}$ "

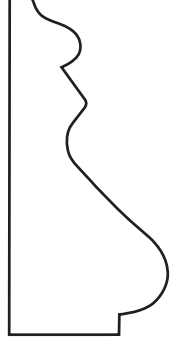

PJ120

$\frac{7}{8}$ " X 2"



PJ135

$1\frac{1}{16}$ " X $2\frac{1}{8}$ "



PJ118

$\frac{7}{8}$ " X $2\frac{1}{16}$ "

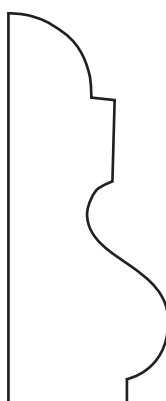

PJ138

$1\frac{1}{16}$ " X $2\frac{1}{16}$ "

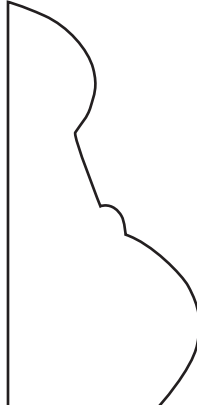

PJ119

$1\frac{1}{16}$ " X $1\frac{7}{8}$ "

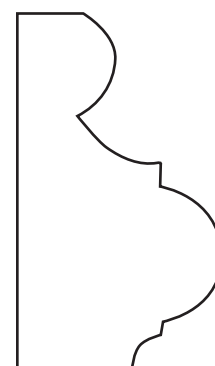

PJ122

$1\frac{1}{16}$ " X $1\frac{13}{16}$ "

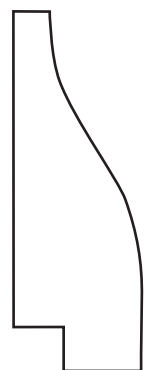

PJ106

$1\frac{1}{16}'' \times 1\frac{5}{16}''$

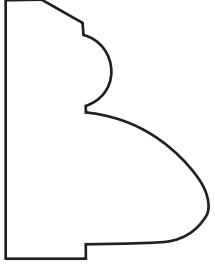

PJ149

$1\frac{3}{16}'' \times 1\frac{1}{4}''$

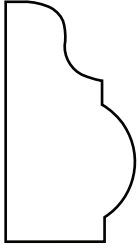

PJ142

$\frac{7}{8}'' \times 1\frac{5}{16}''$

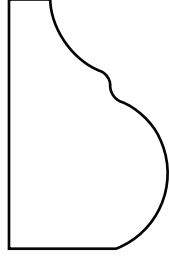

PJ134

$1\frac{1}{16}'' \times 1\frac{5}{8}''$



PJ146

$1\frac{1}{8}'' \times 1\frac{7}{8}''$

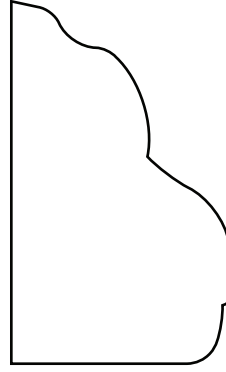

PJ145

$1\frac{3}{16}'' \times 2\frac{1}{16}''$

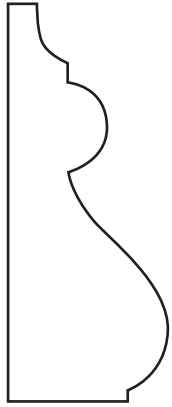

PJ154

$\frac{7}{8}'' \times 1\frac{5}{16}''$

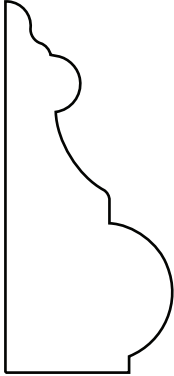

PJ143

$1\frac{3}{16}'' \times 2\frac{7}{8}''$

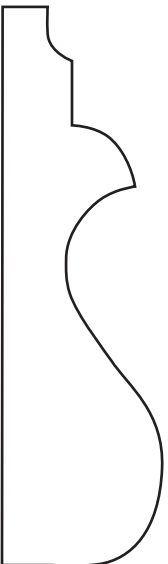

PJ131

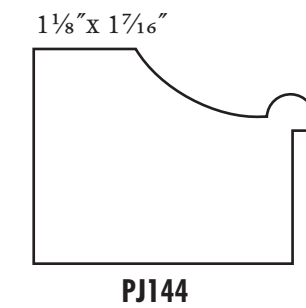
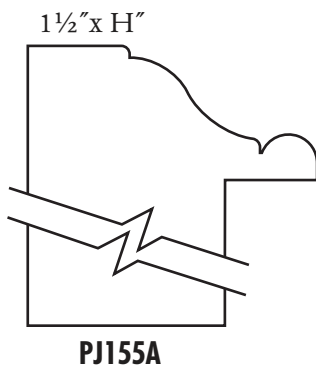
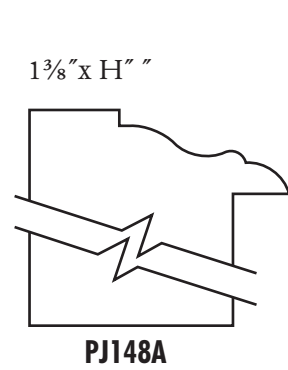
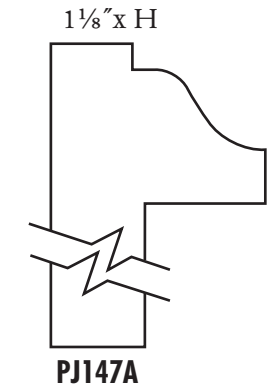
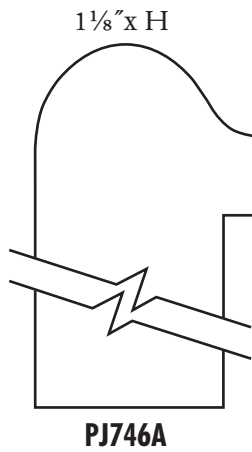
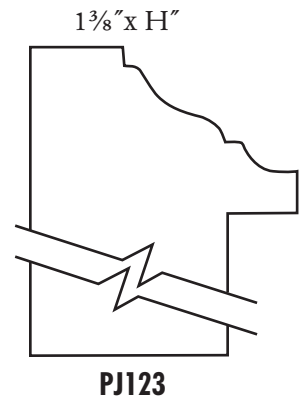
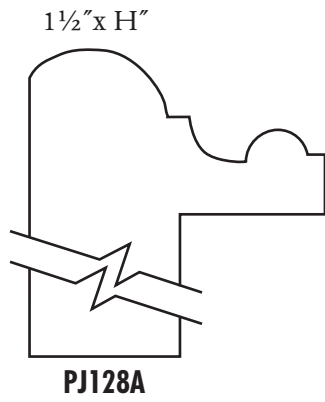
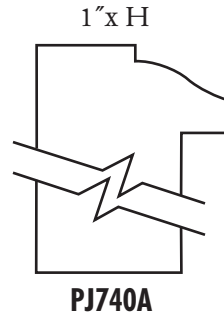
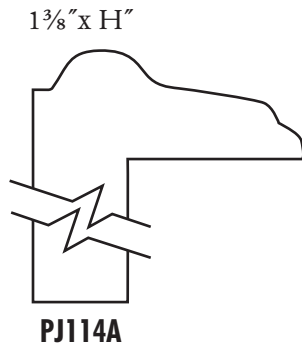
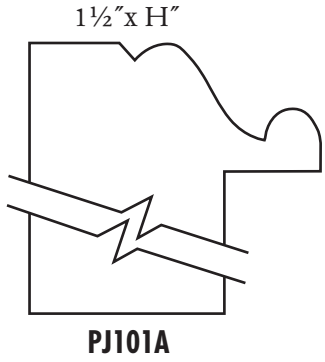

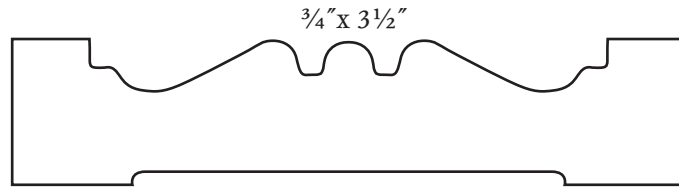

8296

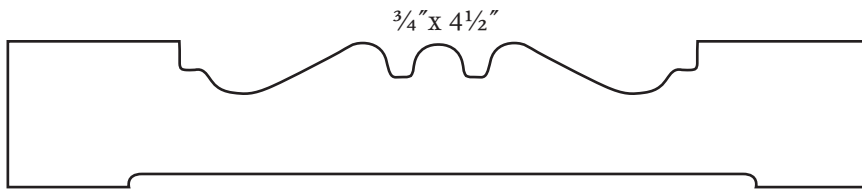

8297

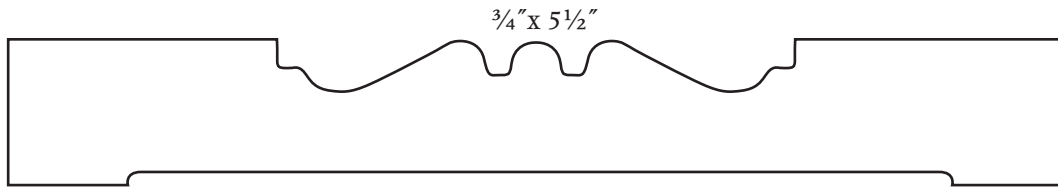

8298

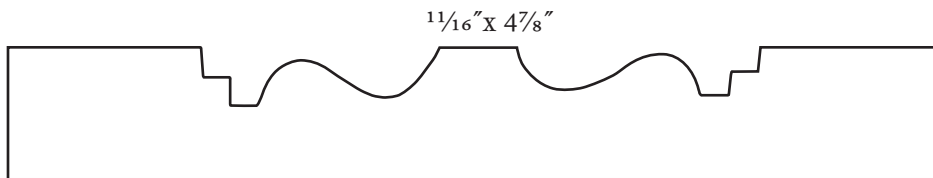

PJ237

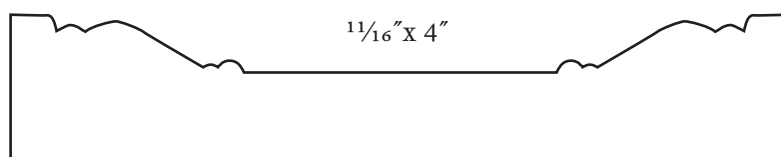

PJ217

$1\frac{1}{16}'' \times 3\frac{1}{4}''$

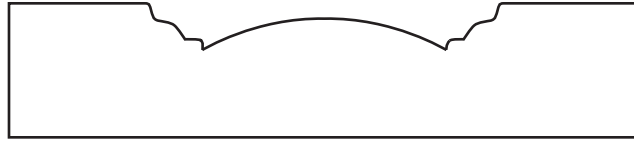

PJ219

$\frac{3}{4}'' \times 4\frac{1}{4}''$

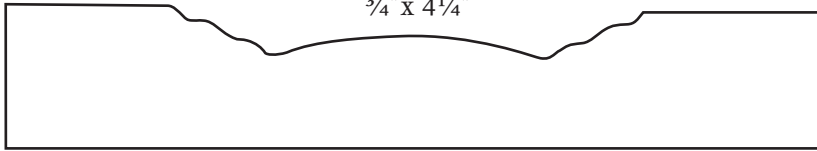

B100

$\frac{3}{4}'' \times 4\frac{1}{2}''$

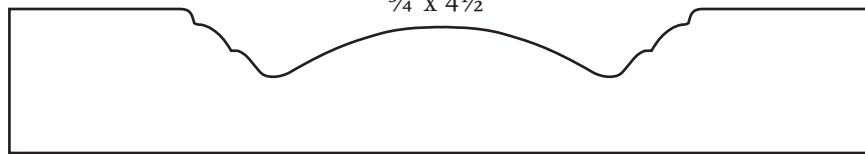

PJ222

$\frac{3}{4}'' \times 4''$

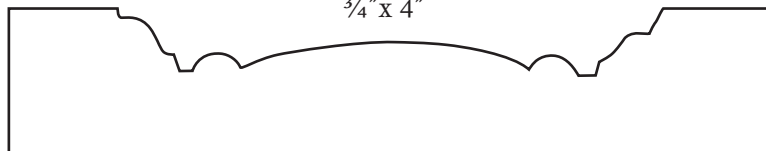

PJ242

$\frac{7}{8}'' \times 5''$

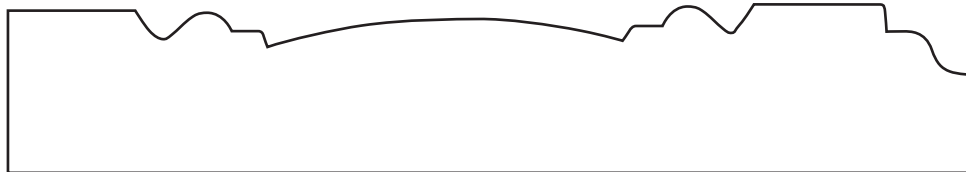

PJ247

$\frac{3}{4}'' \times 4\frac{7}{8}''$

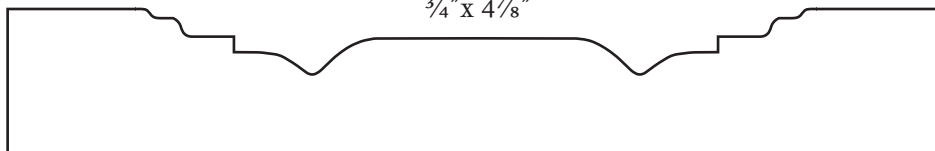

PJ244

$1\frac{3}{16}'' \times 4\frac{1}{2}''$

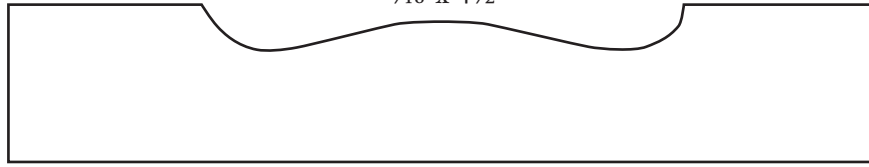

PJ231

$1\frac{1}{16}'' \times 5''$

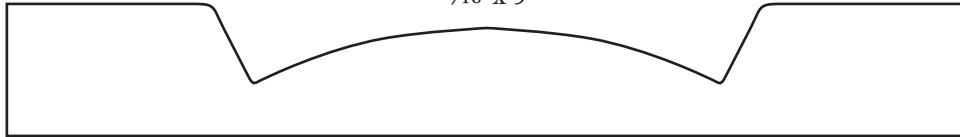

PJ228

$\frac{3}{4}'' \times 3\frac{3}{4}''$

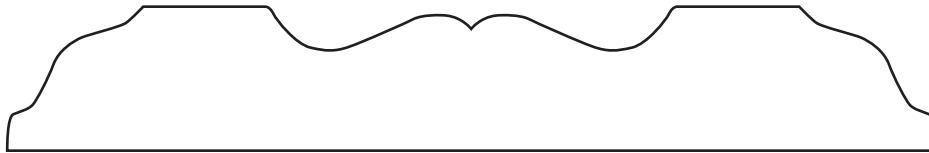

PJ220

$1\frac{1}{8}'' \times 5''$

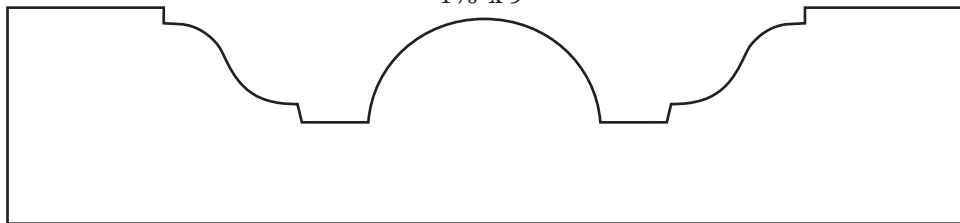

PJ230

$1\frac{5}{16}'' \times 6''$

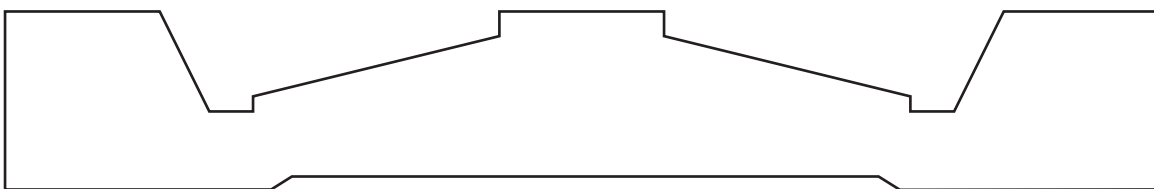

PJ212

$\frac{3}{4}'' \times 5''$

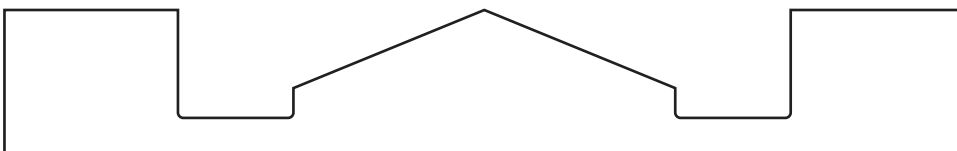

PJ235

$\frac{3}{4}'' \times 3\frac{1}{2}''$

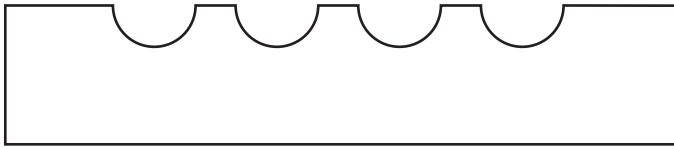

PJ207

$\frac{3}{4}'' \times 3\frac{1}{2}''$

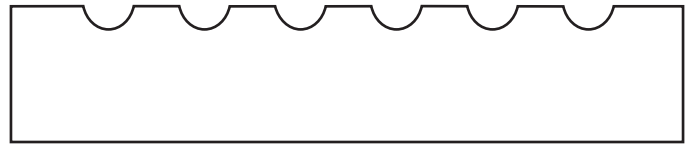

PJ200

$1\frac{1}{16}'' \times 3\frac{7}{8}''$

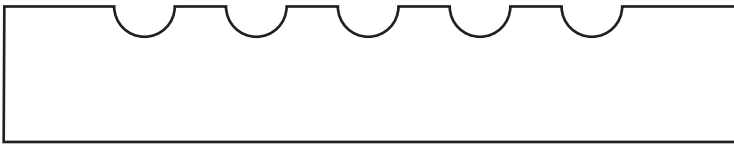

PJ2002

$\frac{3}{4}'' \times 4\frac{1}{8}''$

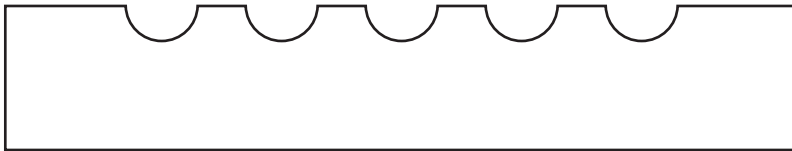

PJ210

$\frac{3}{4}'' \times 4\frac{3}{4}''$

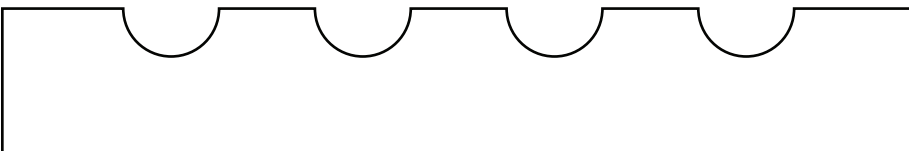

PJ226

$\frac{3}{4}'' \times 5\frac{1}{2}''$

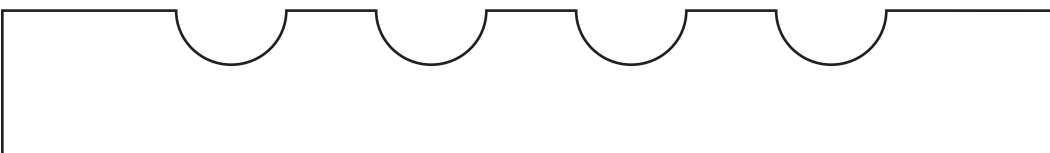

PJ206

$\frac{1}{2}'' \times 3\frac{3}{8}''$



PJ245

$1\frac{1}{16}'' \times 2\frac{15}{16}''$

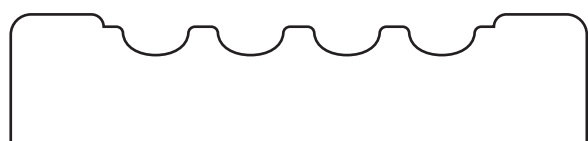

PJ252

$\frac{3}{4}'' \times 3\frac{1}{2}''$



PJ205

$\frac{3}{4}'' \times 4\frac{1}{2}''$



PJ205A

$\frac{3}{4}'' \times 3\frac{1}{2}''$



PJ213

$1\frac{1}{16}'' \times 3''$



PJ264

$1\frac{1}{16}'' \times 3\frac{1}{8}''$

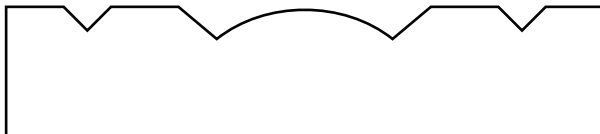

PJ275

$1\frac{1}{16}'' \times 3\frac{3}{8}''$

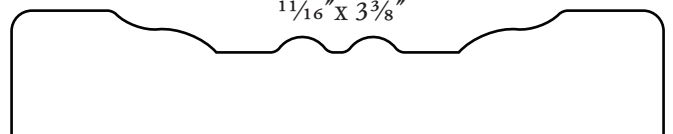

PJ272

$1\frac{3}{16}'' \times 4''$

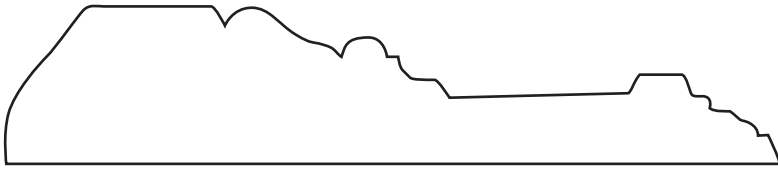

PJ214

$1\frac{1}{16}'' \times 2\frac{1}{2}''$

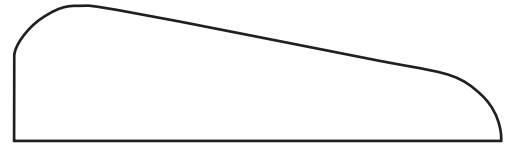

PJ211

$1\frac{1}{16}'' \times 4\frac{1}{4}''$

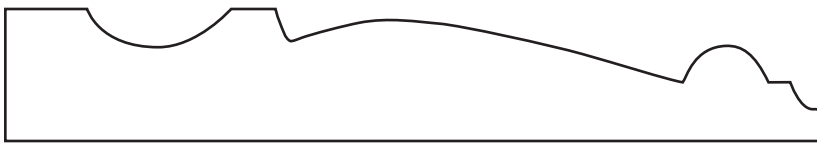

PJ215

$1\frac{1}{16}'' \times 2\frac{1}{2}''$

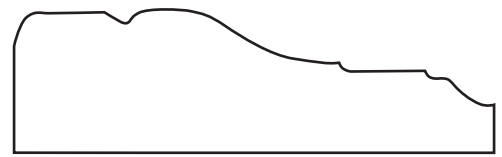

**8753
WP361**

$1\frac{3}{16}'' \times 3\frac{5}{8}''$

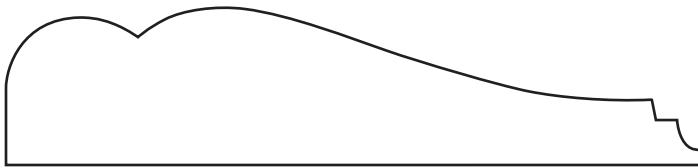

PJ236

$1\frac{1}{16}'' \times 2\frac{1}{2}''$



**8710
WP351**

$\frac{3}{4}'' \times 3\frac{1}{2}''$

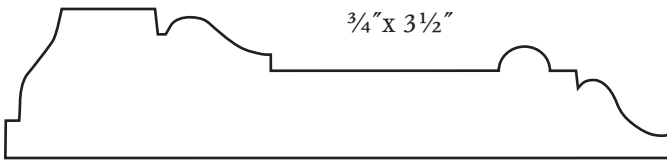

PJ241

$1\frac{1}{16}'' \times 2\frac{1}{2}''$

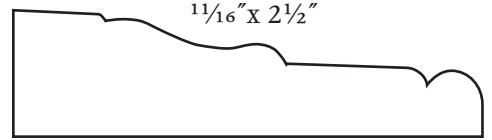

8725

$1\frac{1}{4}'' \times 2\frac{1}{2}''$

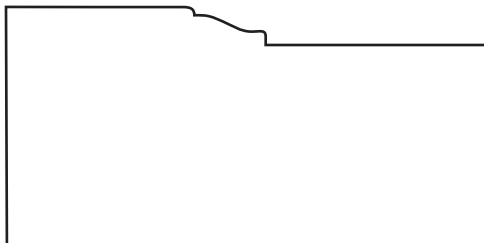

908A

$1\frac{1}{4}'' \times 2''$

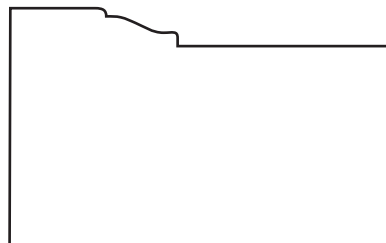

908

$1\frac{1}{16}'' \times 3\frac{1}{2}''$

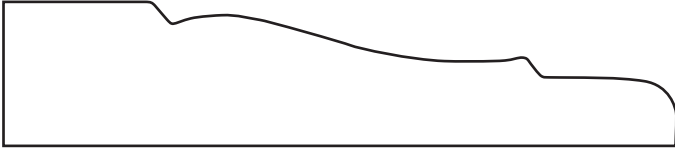

8754

$1\frac{1}{16}'' \times 3\frac{1}{4}''$



PJ203

$1\frac{1}{16}'' \times 3\frac{1}{2}''$

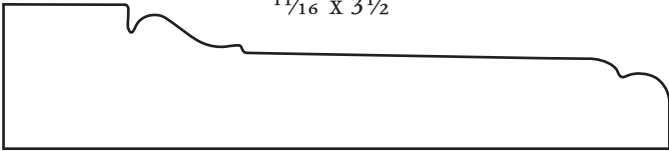

PJ204

$1\frac{1}{16}'' \times 3\frac{3}{8}''$

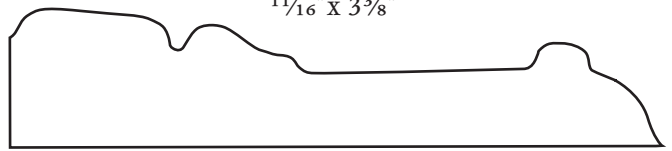

PJ201

$1\frac{1}{16}'' \times 3\frac{1}{2}''$

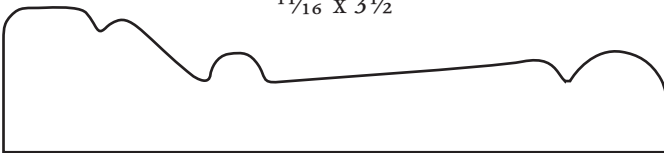

B225

$1'' \times 3\frac{1}{2}''$

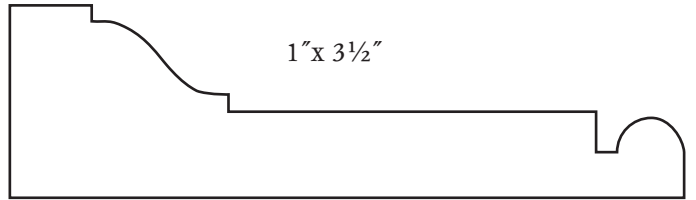

PJ208

$1\frac{1}{16}'' \times 3\frac{1}{2}''$

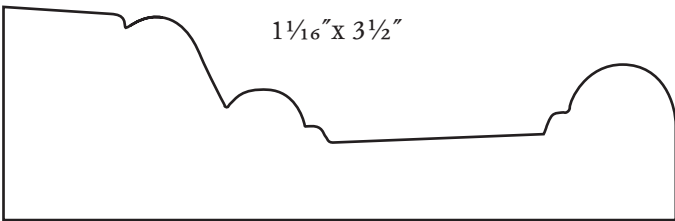

B200

$1\frac{1}{16}'' \times 3\frac{1}{2}''$



PJ302

$1\frac{1}{16}'' \times 3\frac{1}{2}''$

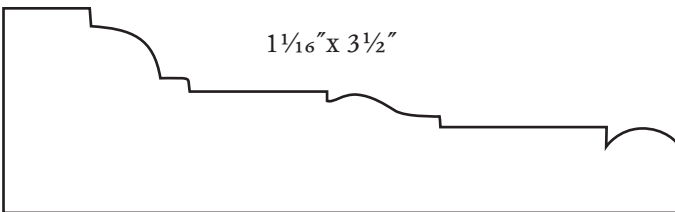

PJ216

$1\frac{3}{16}'' \times 3\frac{1}{2}''$

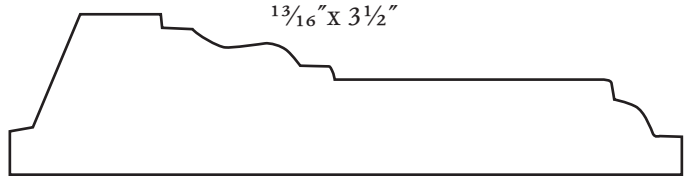

PJ223

$1\frac{1}{16}'' \times 3\frac{7}{16}''$

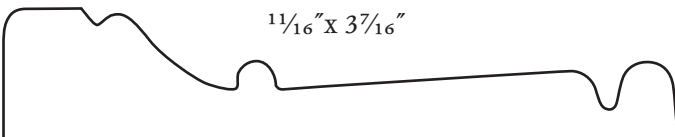

Stafford

$1\frac{1}{16}'' \times 3\frac{1}{2}''$

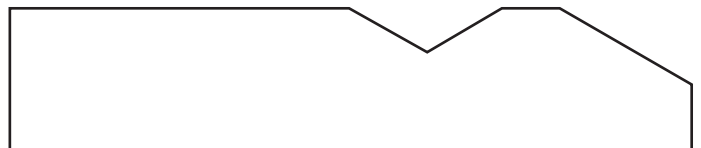

PJ218

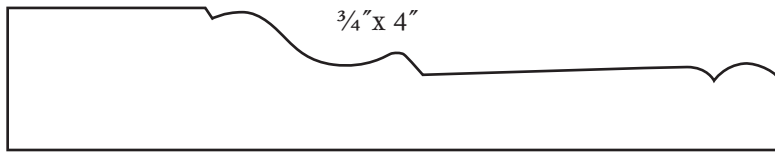

PJ221

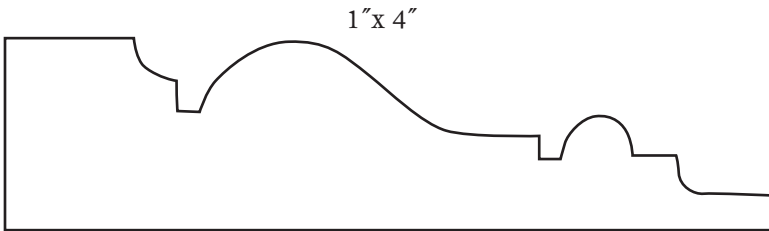

PJ224 (KW3142)

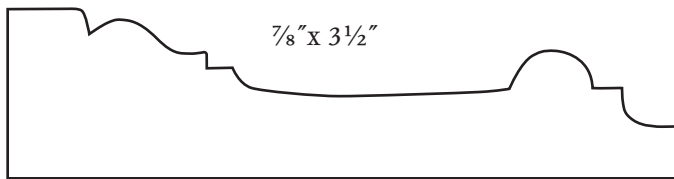

PJ246

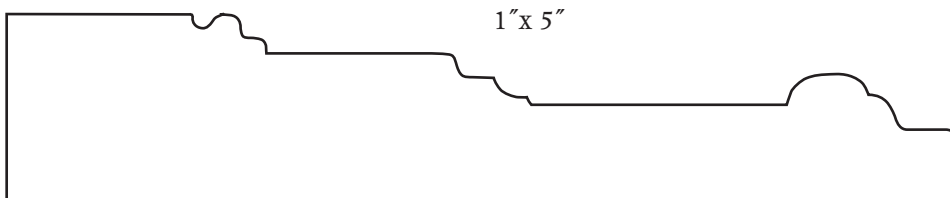

PJ243

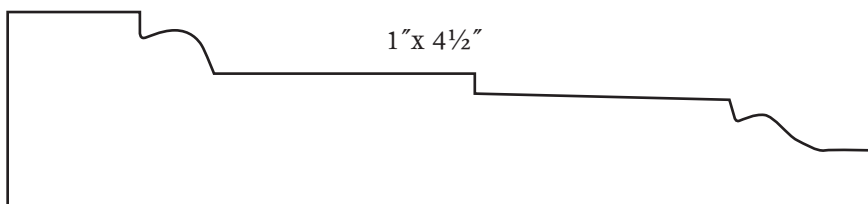

PJ225

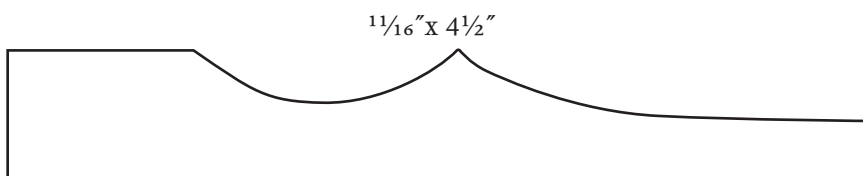

PJ233

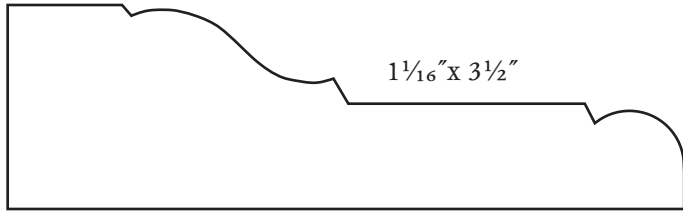

PJ250 (KW2238)

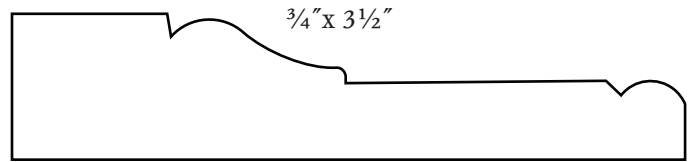

PJ256

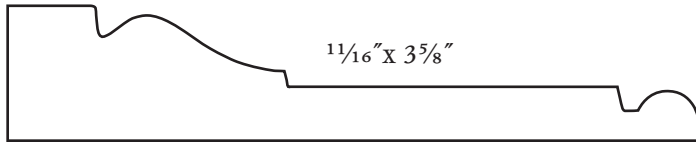

PJ227

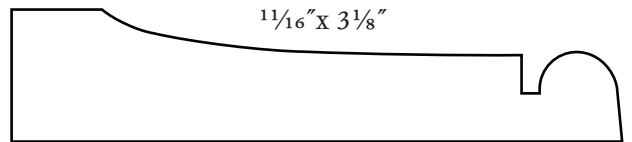

PJ229

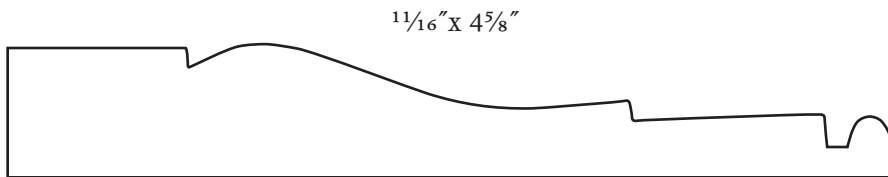

PJ238

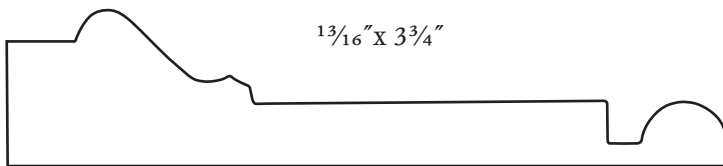

PJ239

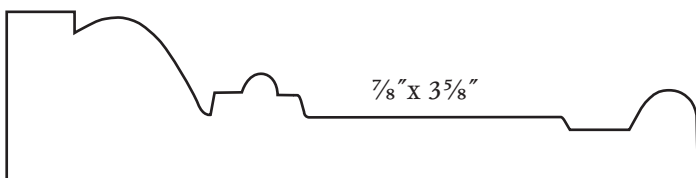

PJ251

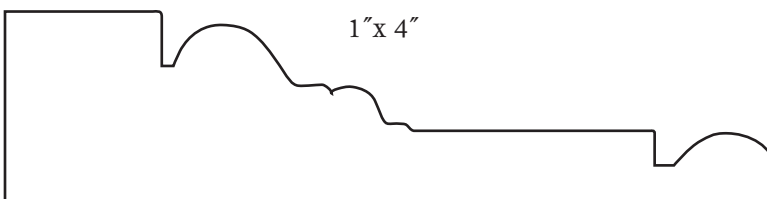

PJ232

$\frac{3}{4}$ " x $4\frac{1}{2}$ "

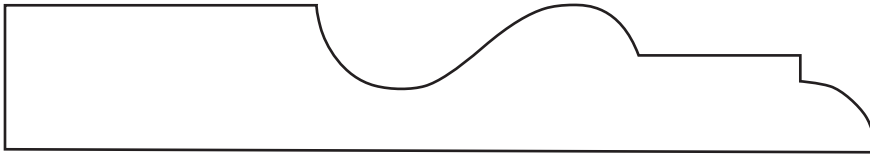

PJ240

$1\frac{3}{16}$ " x $5\frac{1}{2}$ "

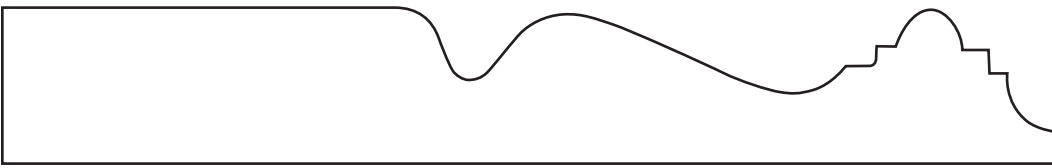

PJ303

$1\frac{1}{16}$ " x $4\frac{1}{2}$ "

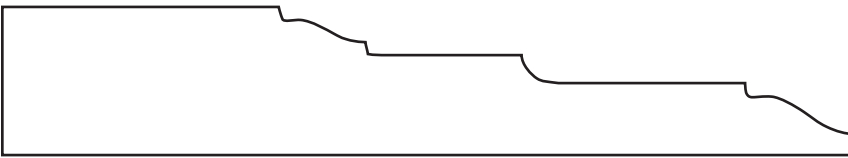

PJ209

$1\frac{1}{16}$ " x $4\frac{1}{2}$ "

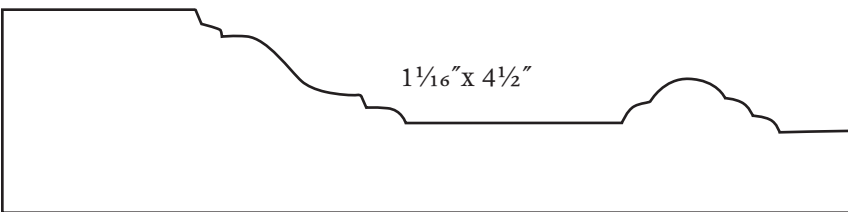

PJ248

PJ107

$1\frac{1}{4}$ " x 5" (combined)

PJ229

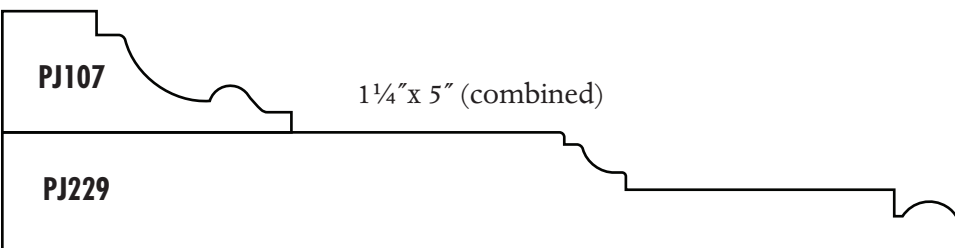

PJ229 & PJ107

$\frac{3}{4}$ " x $3\frac{1}{2}$ "

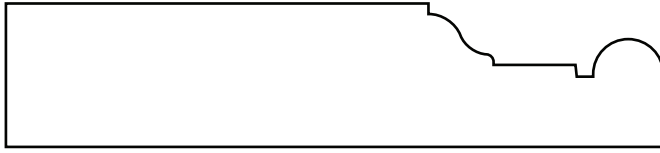

PJ266

$\frac{1}{16}$ " x $3\frac{1}{2}$ "

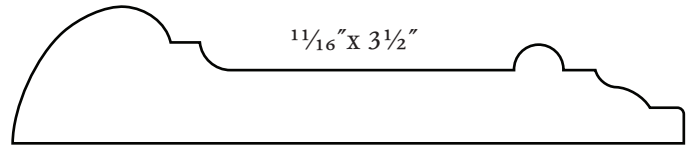

PJ263

$\frac{3}{4}$ " x $3\frac{1}{2}$ "

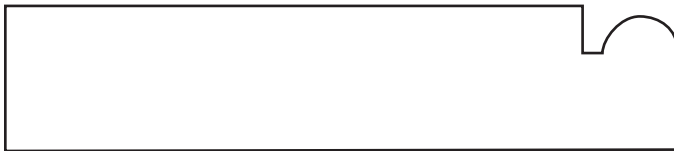

PJ254

1" x $3\frac{5}{8}$ "

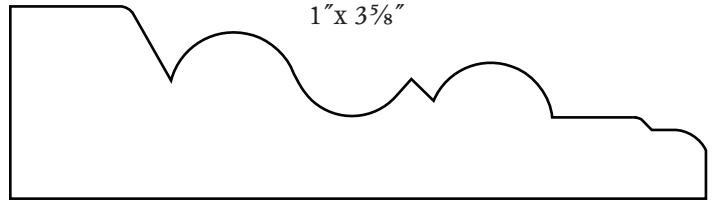

PJ255

$\frac{3}{4}$ " x $3\frac{7}{8}$ "

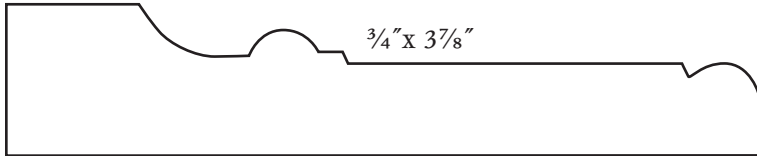

PJ202

1" x $4\frac{1}{4}$ "

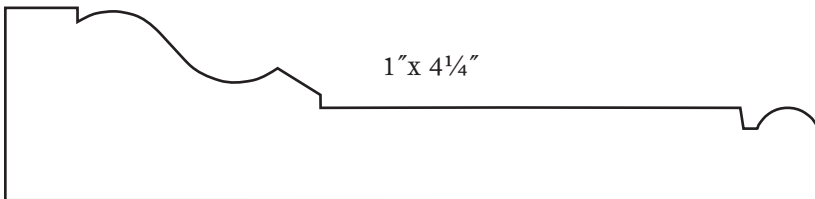

PJ253
KW2744

1" x $4\frac{1}{2}$ "

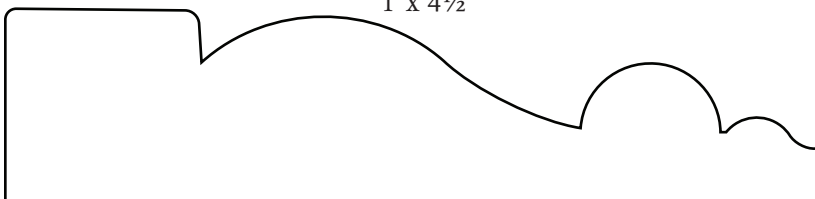

PJ259

$\frac{13}{16}$ " x $4\frac{7}{8}$ "

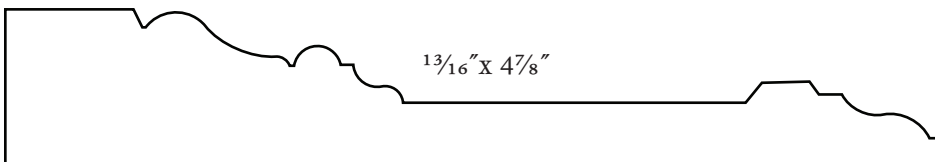

PJ260

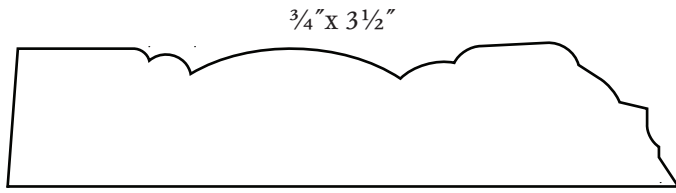

PJ270

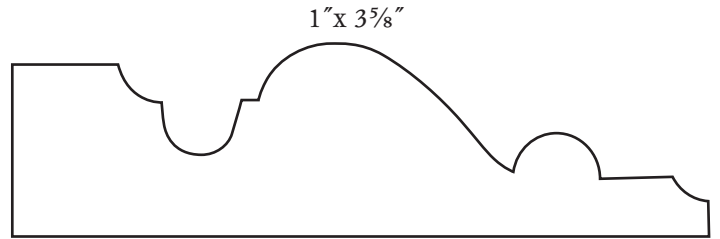

PJ278

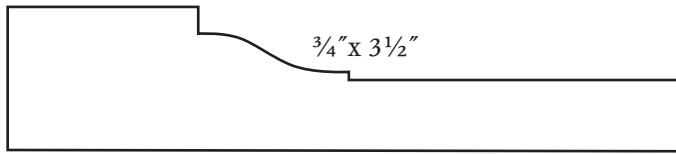

PJ265

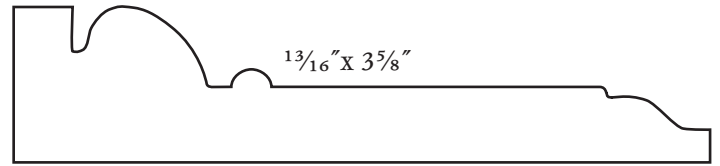

PJ299

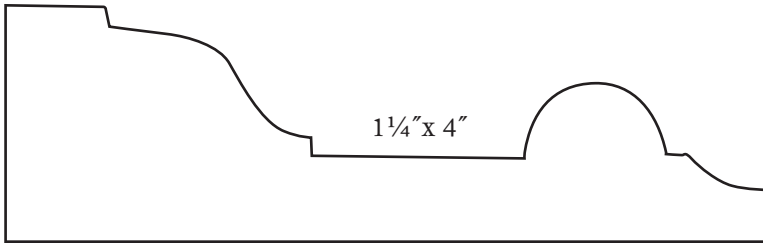

PJ284

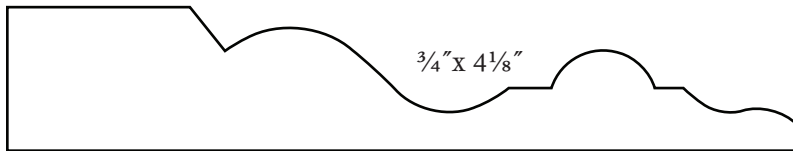

PJ268

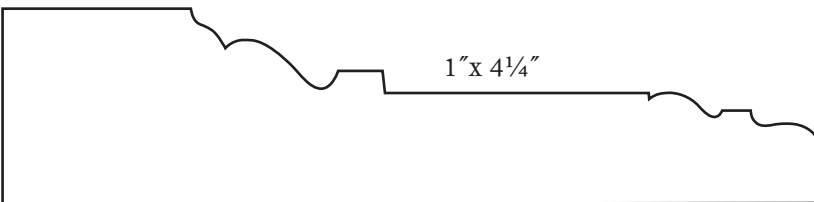

PJ282

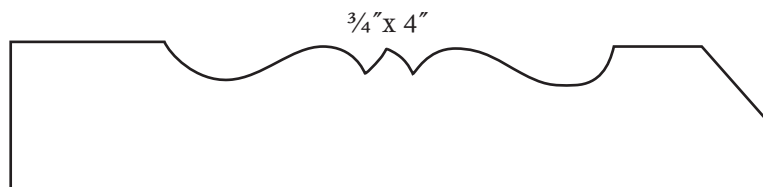

PJ285

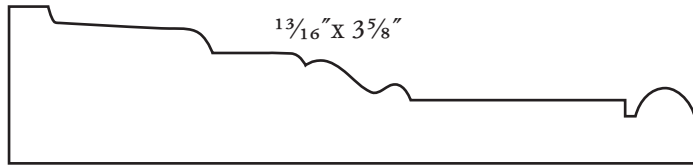

PJ288

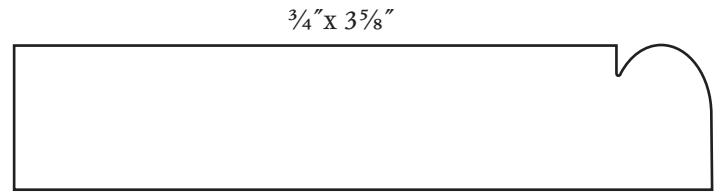

PJ292

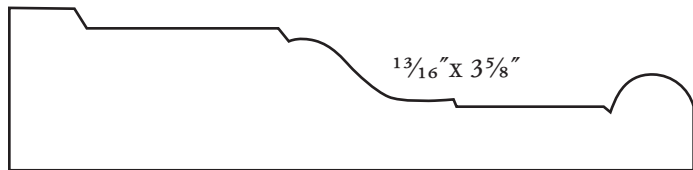

PJ277

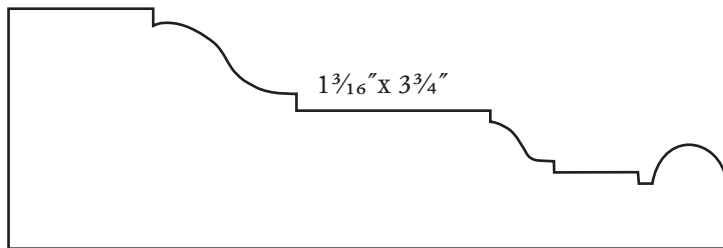

PJ2001

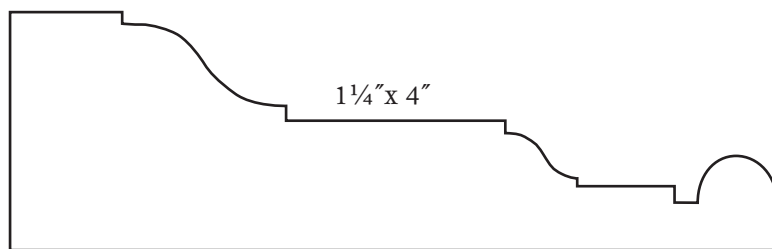

PJ276

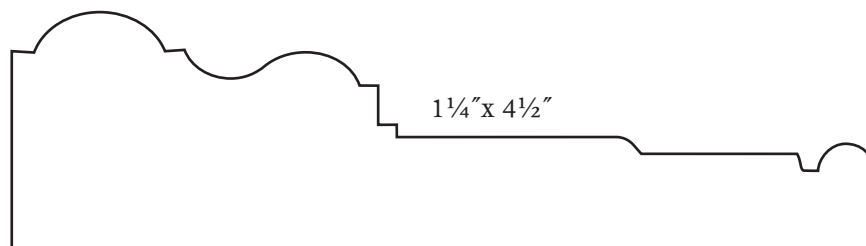

PJ281

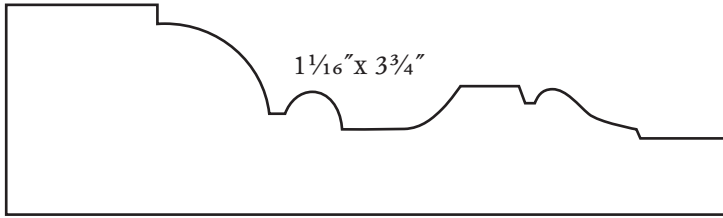

PJ283

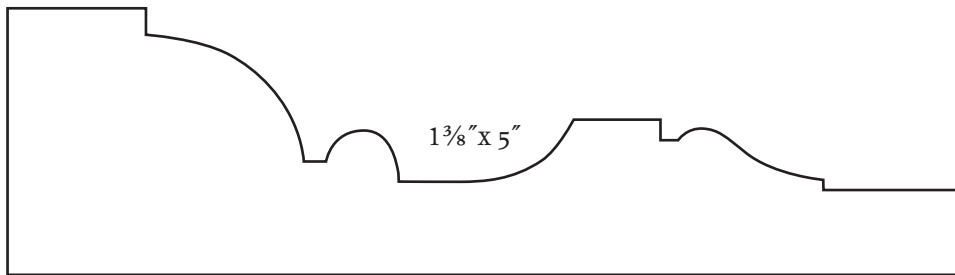

PJ279

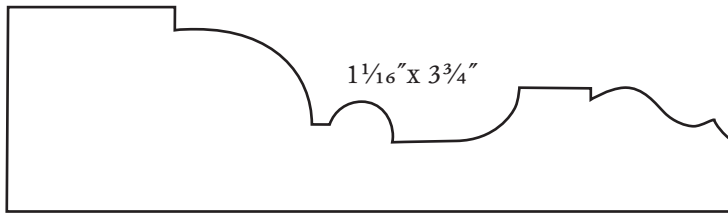

PJ294

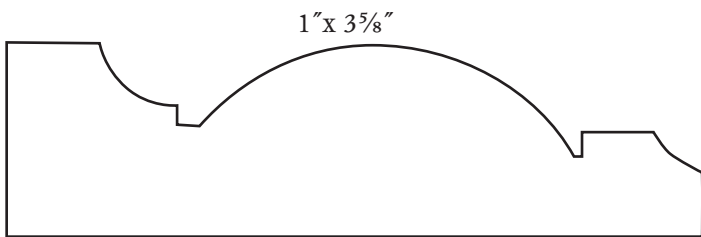

PJ291

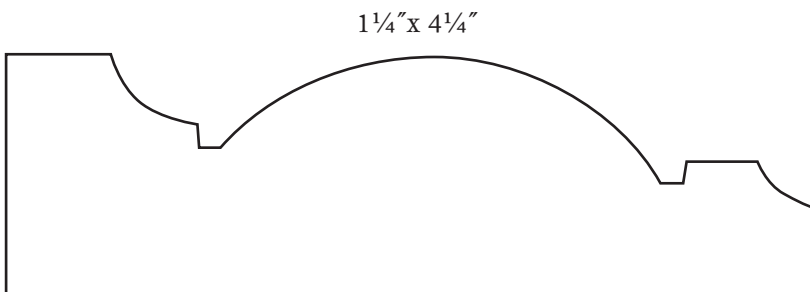

PJ290

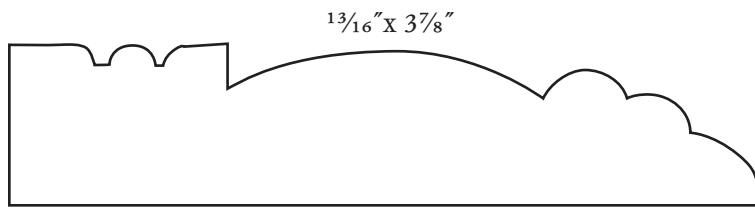

PJ286

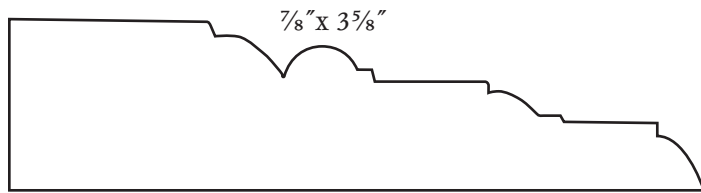

PJ289

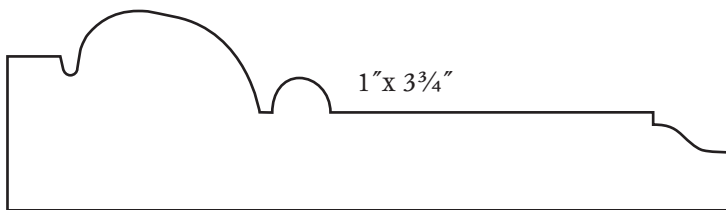

PJ287

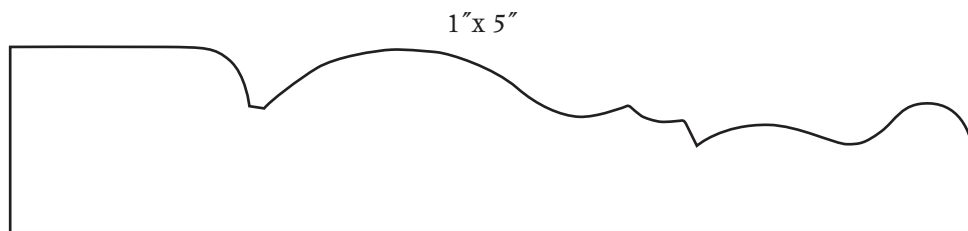

PJ280

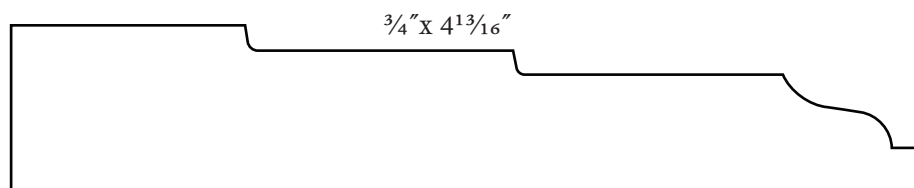

PJ274

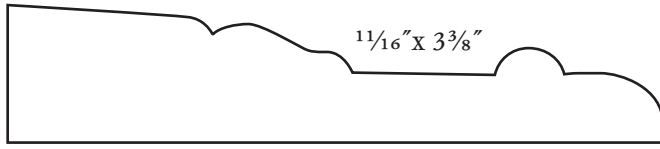

PJ2000

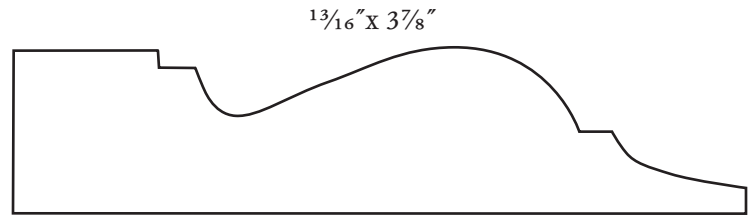

PJ2003

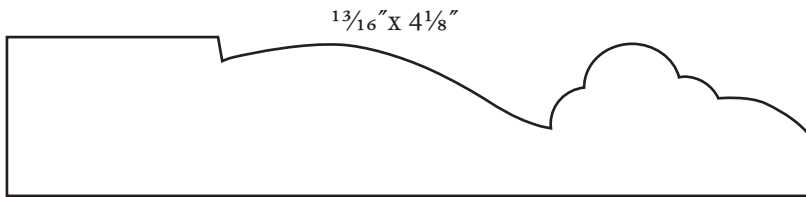

PJ297

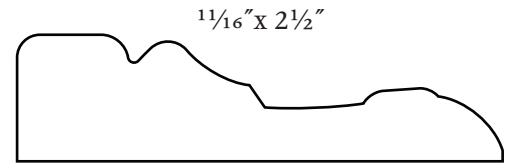

PJ257

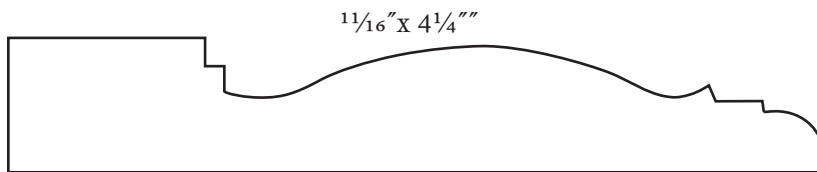

PJ296

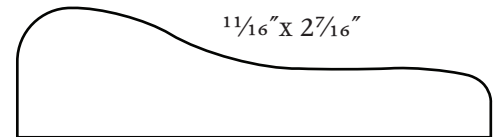

PJ273

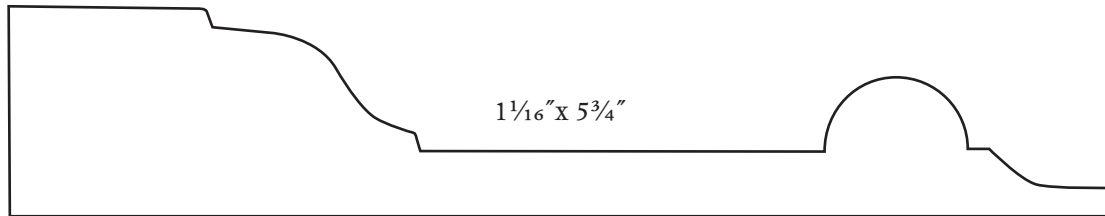

PJ293



PJ2010

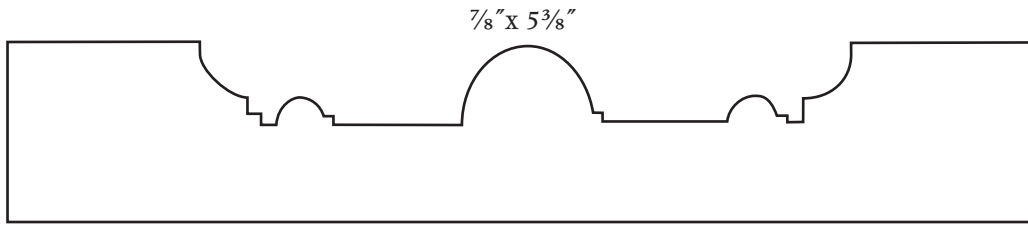

PJ295

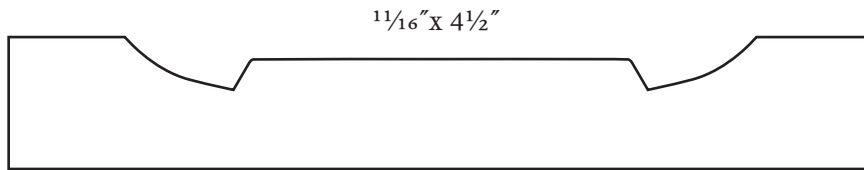

PJ249

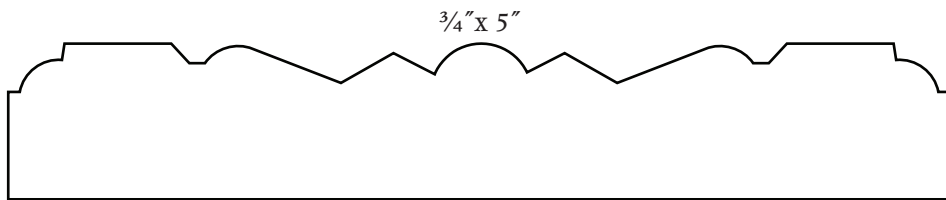

PJ269

$\frac{9}{16}$ " x $4\frac{1}{2}$ "

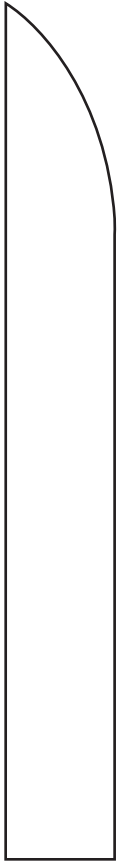

8721

$\frac{9}{16}$ " x $3\frac{1}{2}$ "



8720

$\frac{3}{4}$ " x $3\frac{1}{2}$ "



8385

$\frac{9}{16}$ " x $3\frac{1}{2}$ "

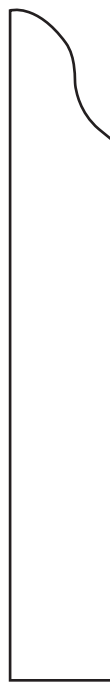

8385A

$\frac{9}{16}$ " x $4\frac{1}{2}$ "

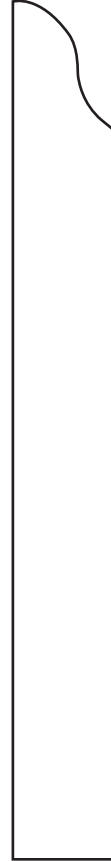

8385B

$\frac{7}{8}$ " x H

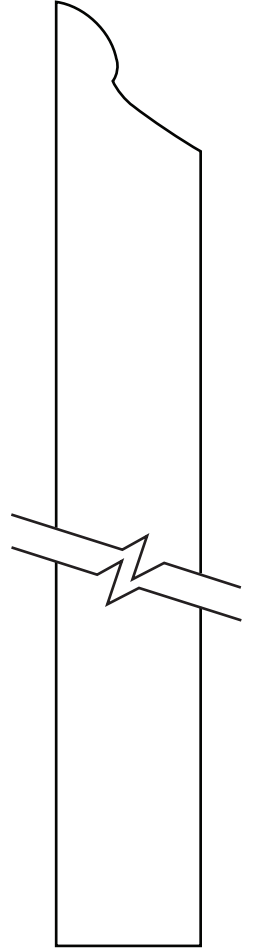

PJ311

$1\frac{3}{16}'' \times 7\frac{1}{4}''$



PJ602A

$1\frac{1}{16}'' \times 5\frac{1}{2}''$



PJ302

$1\frac{3}{16}'' \times 5\frac{1}{2}''$

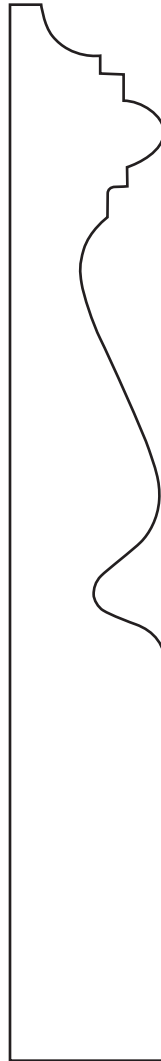

PJ303

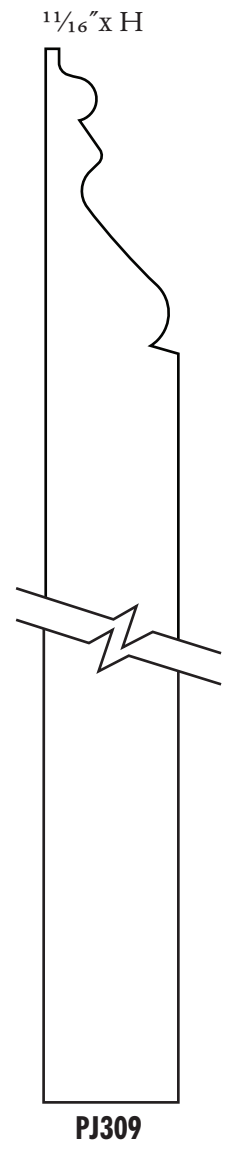
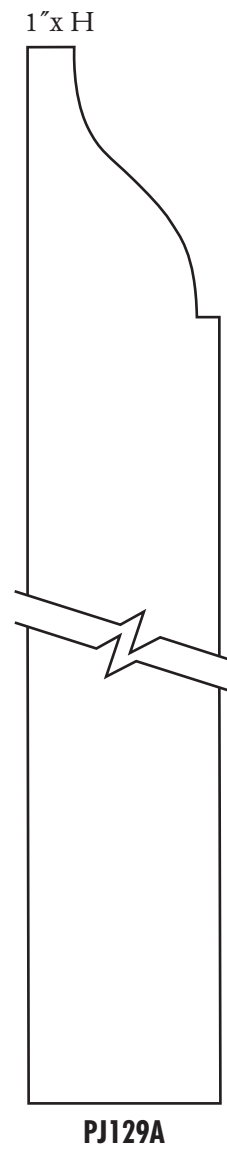
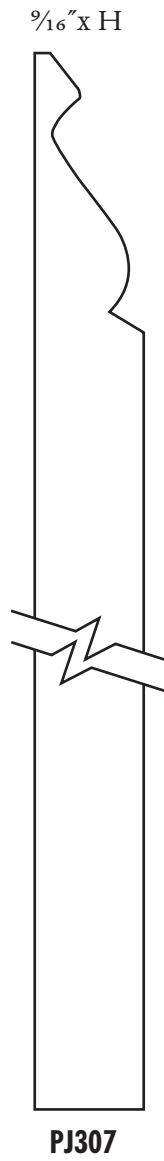
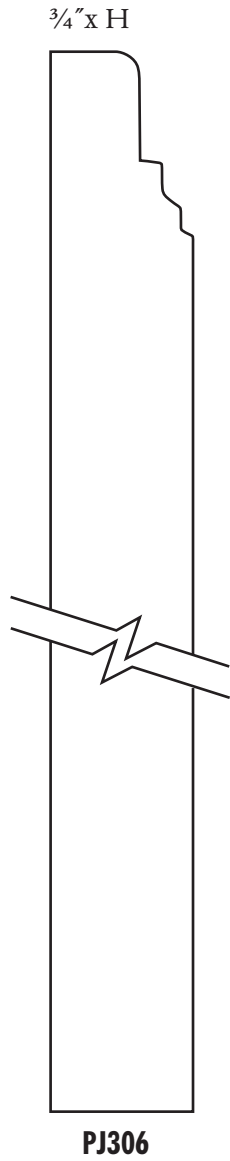
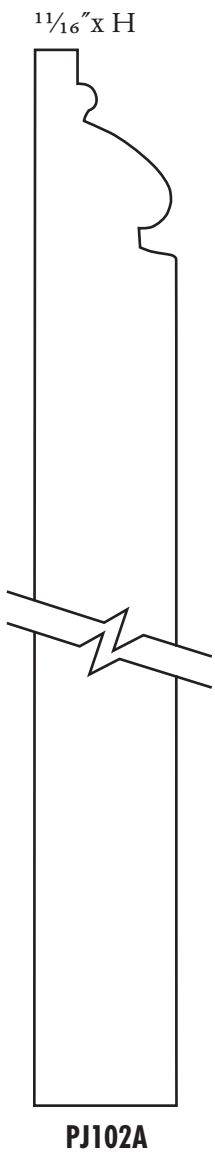

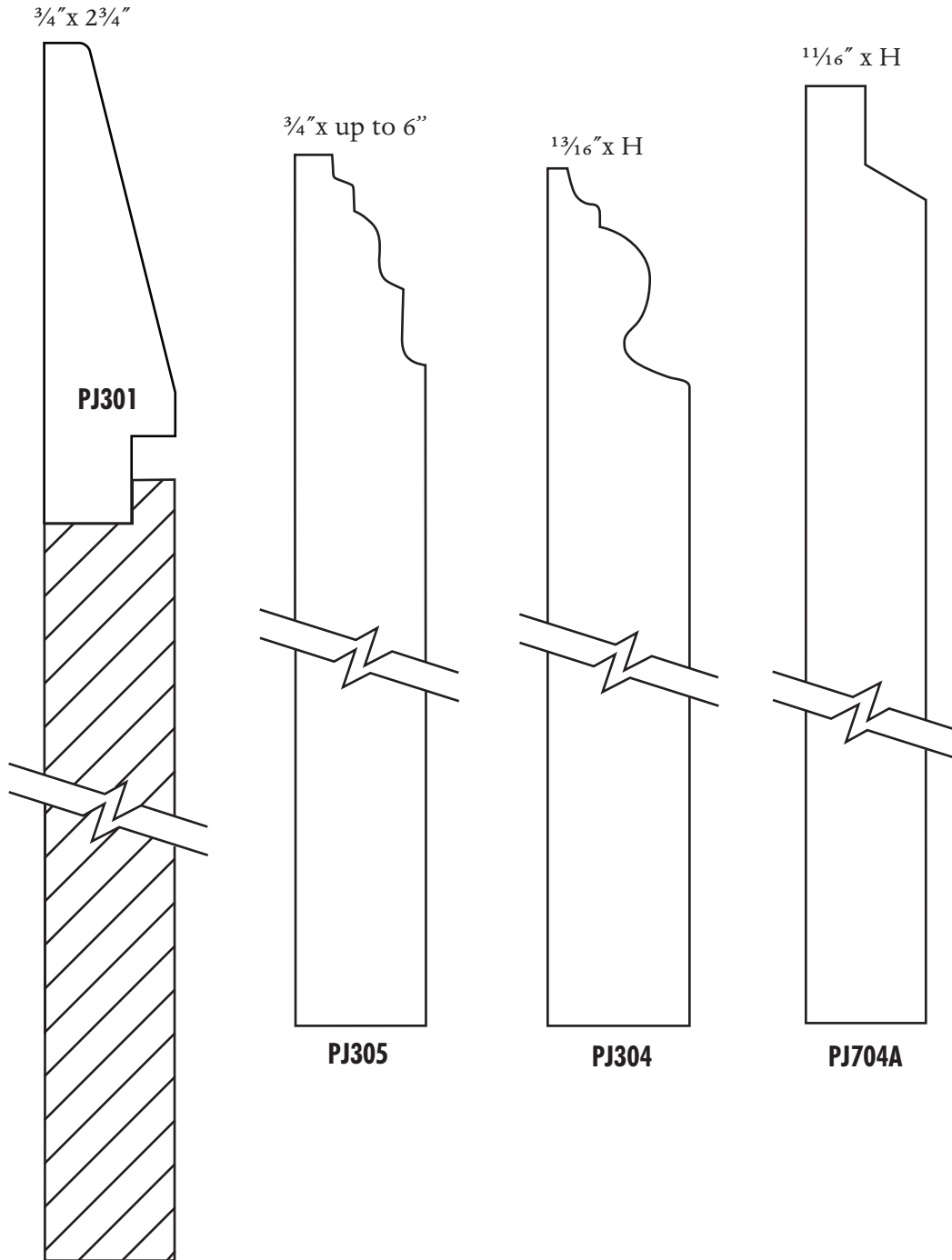

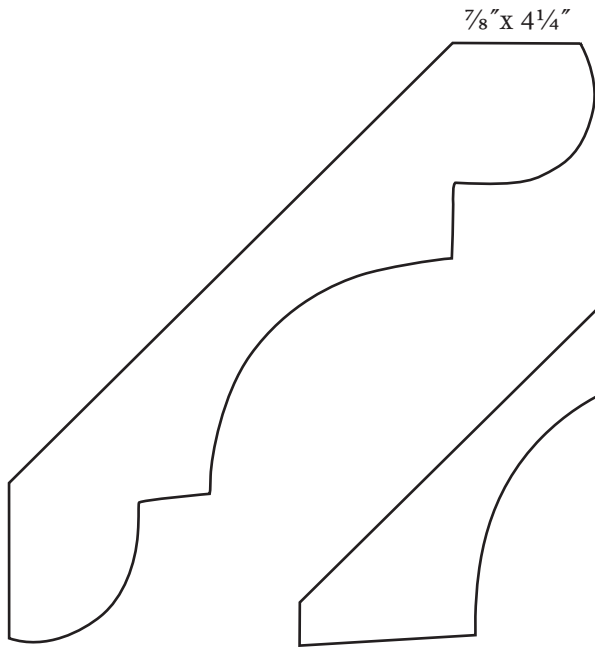

PJ405

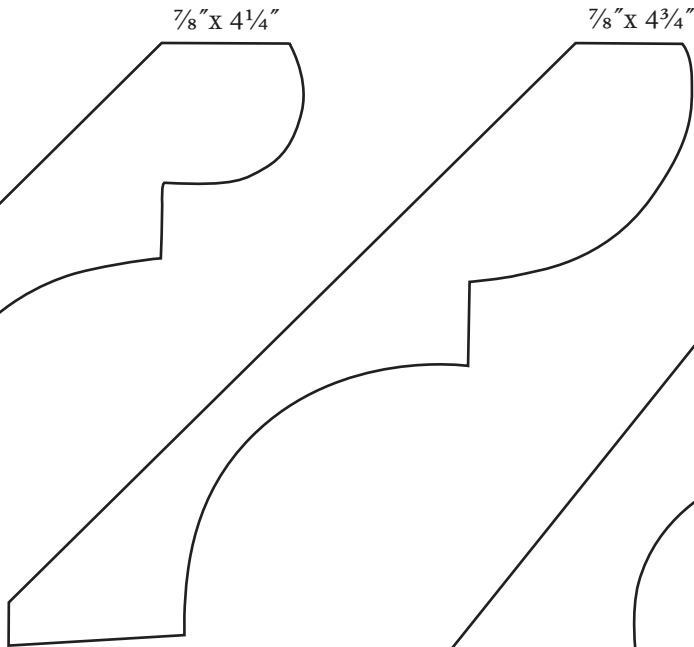

PJ401

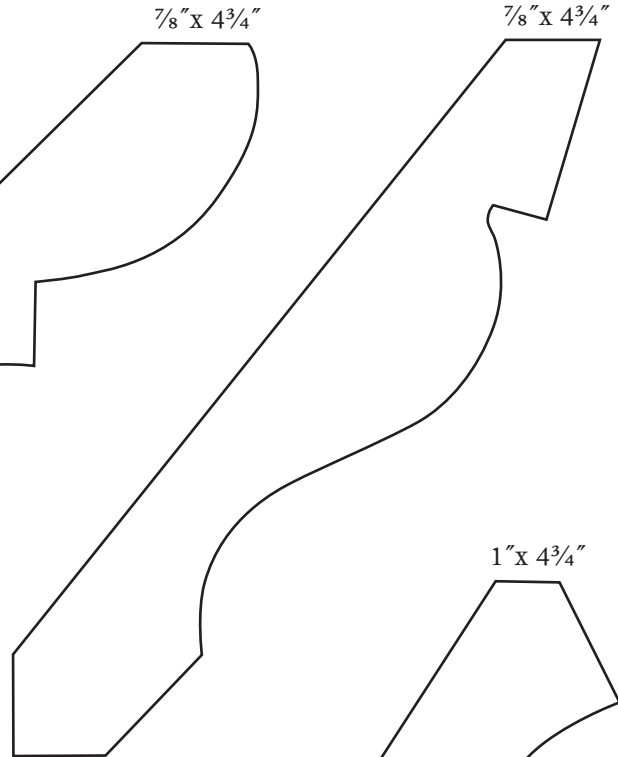

PJ408

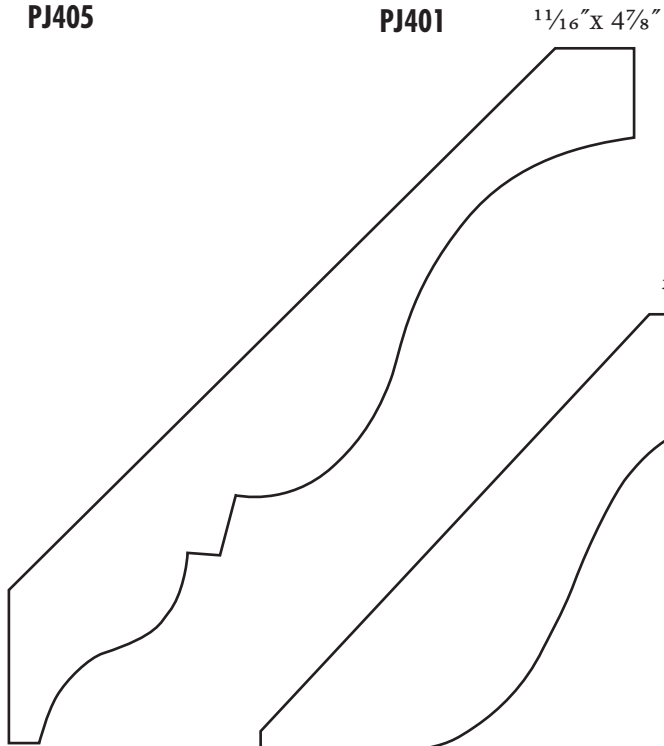

PJ413

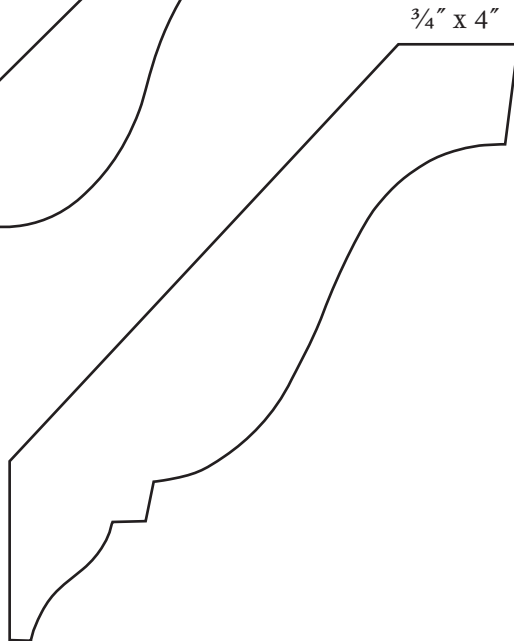

PJ409

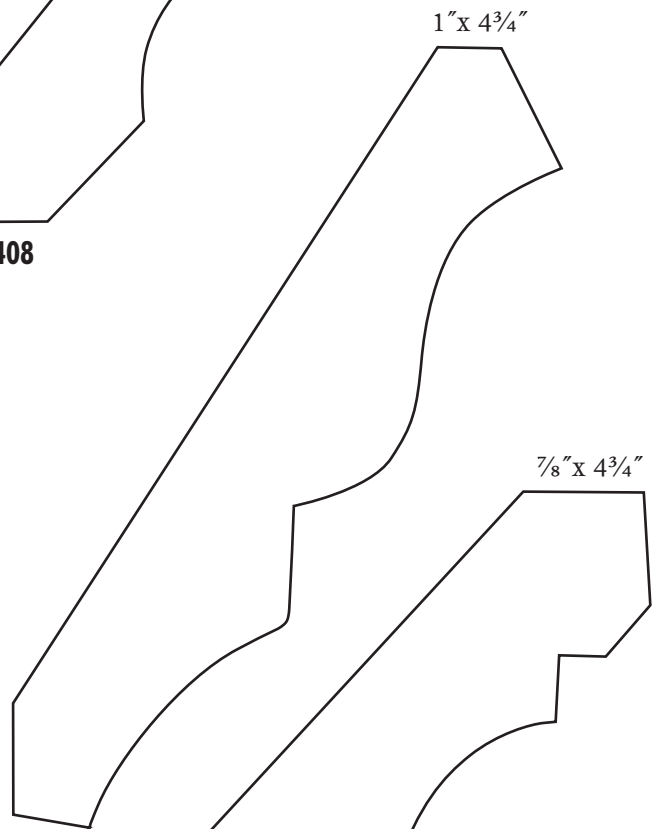

PJ403

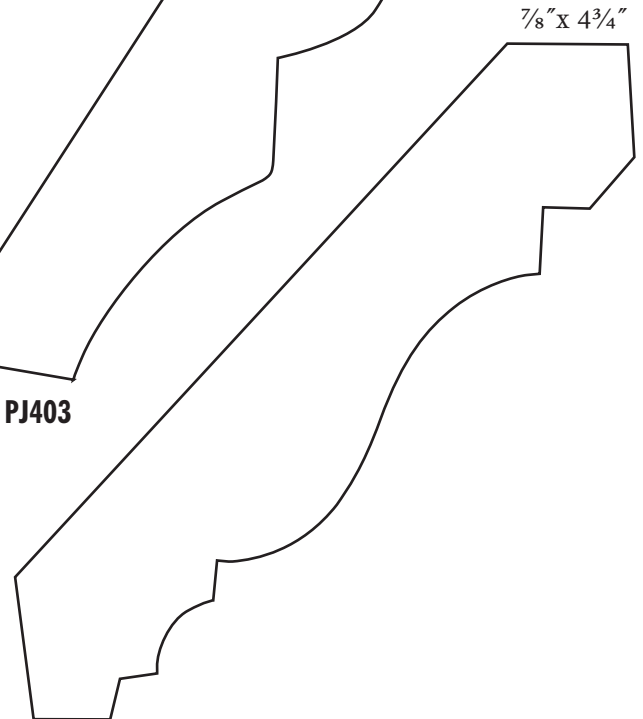

PJ402

PJ Carrier Lumber

CROWN 2

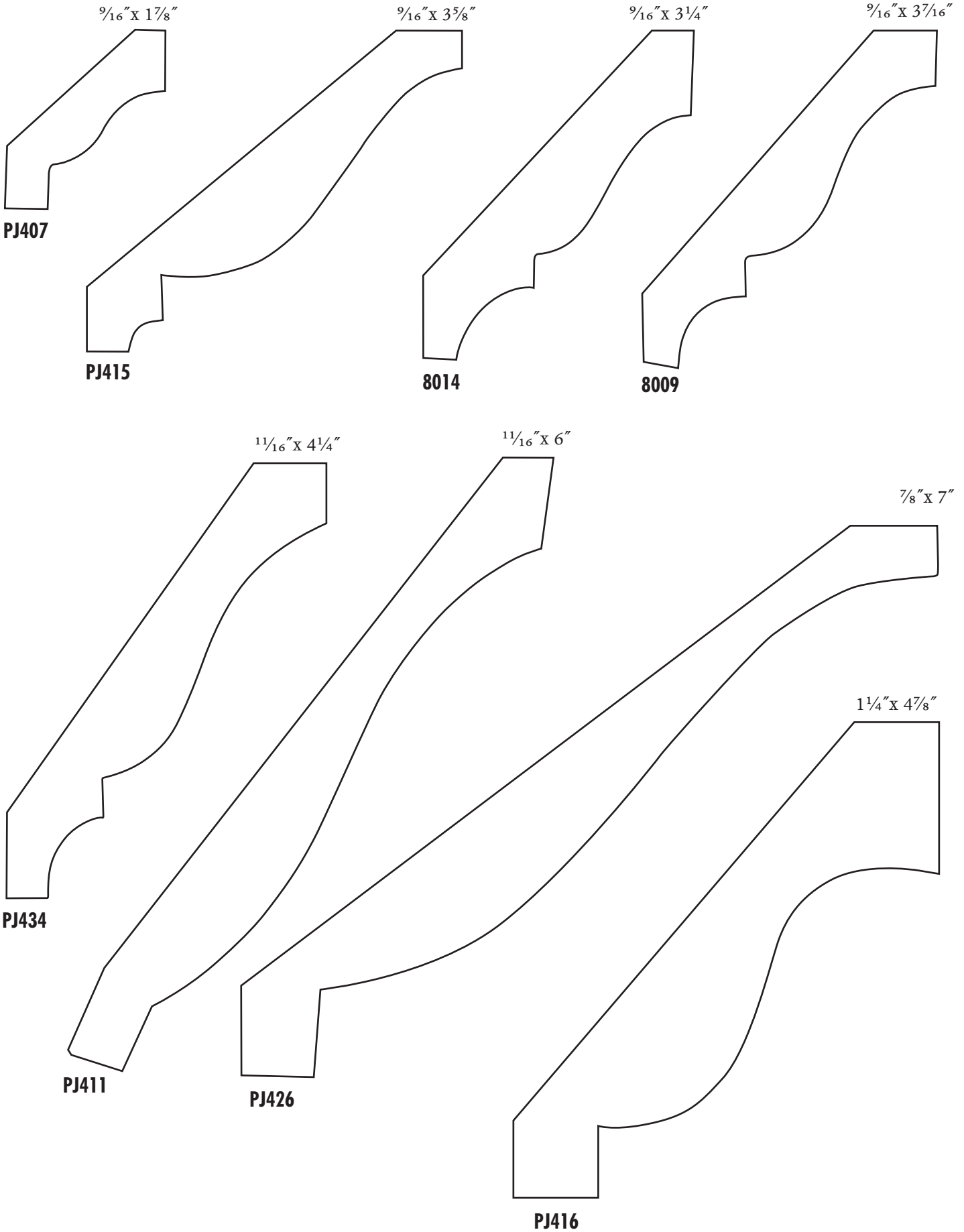

1 1/4" x 3 1/2"

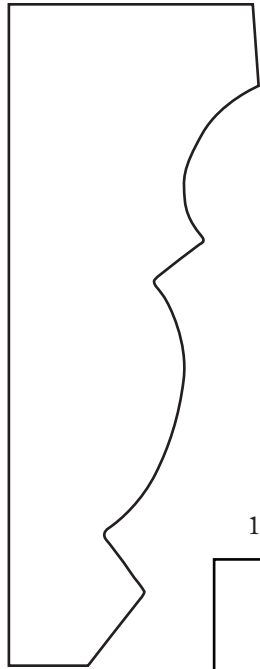

8009
Solid back

1 1/8" x 2 1/4"

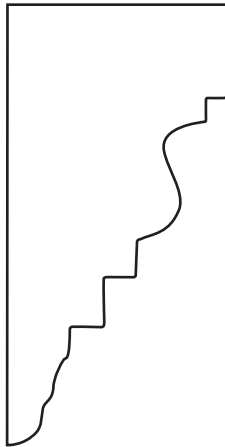

PJ400

7/8" x 2 1/16"

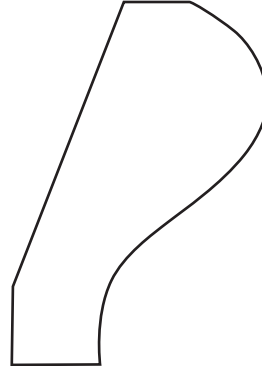

PJ406

9/16" x 1 3/4"

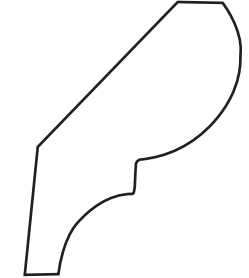

8016

1 1/16" x 2 1/2"

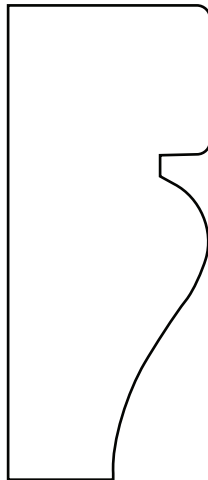

PJ439

1 5/8" x 1 7/8"

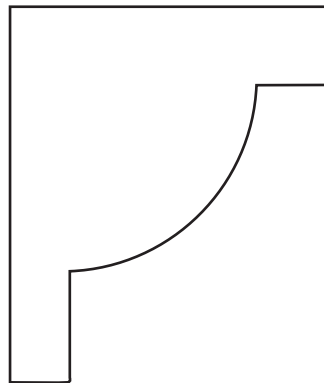

PJ429

1" x 2 3/4"

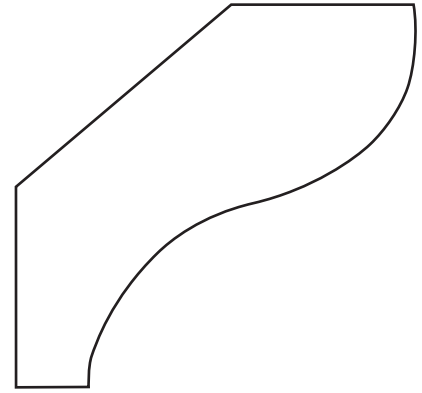

PJ418

1 1/16" x 2 1/2"

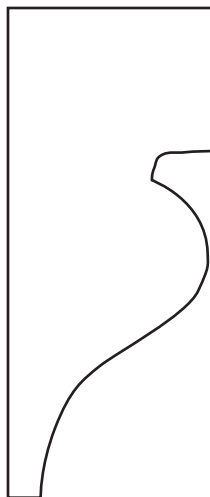

8047

1 5/8" x 2 7/8"

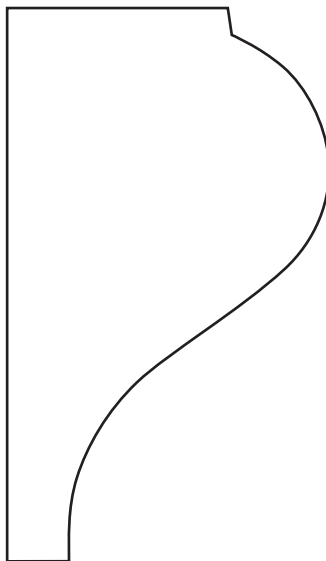

PJ410

2" x 3 1/4"

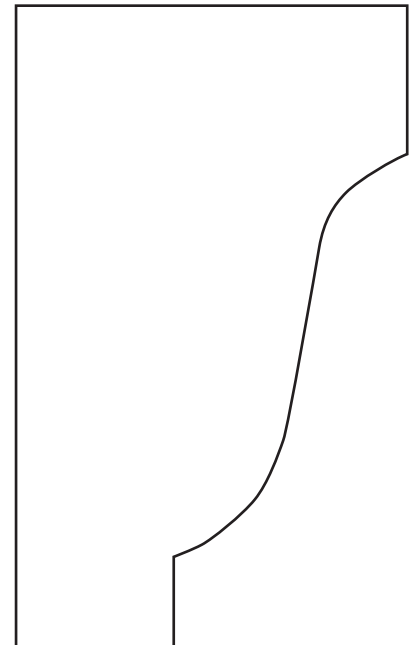

PJ414

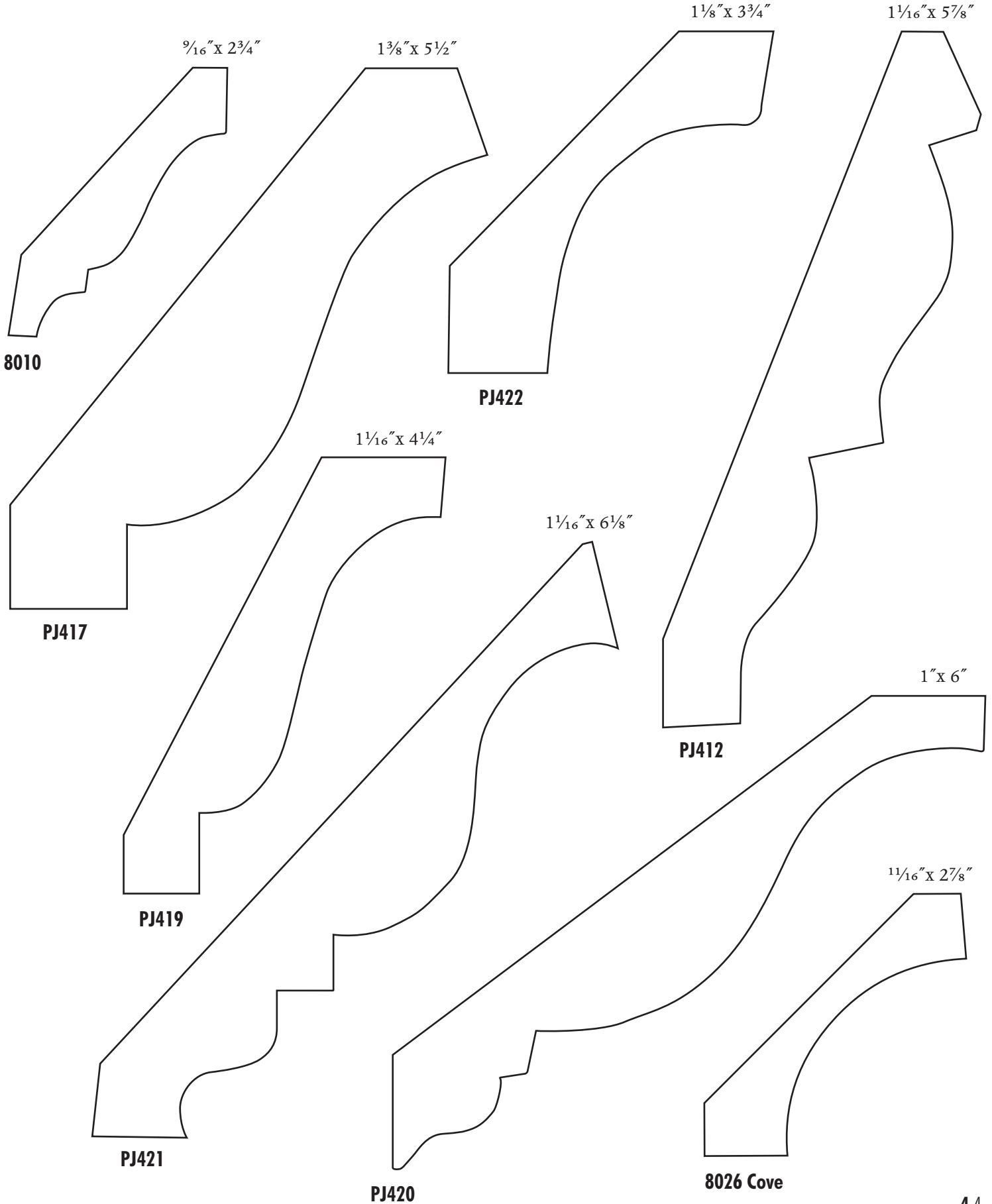

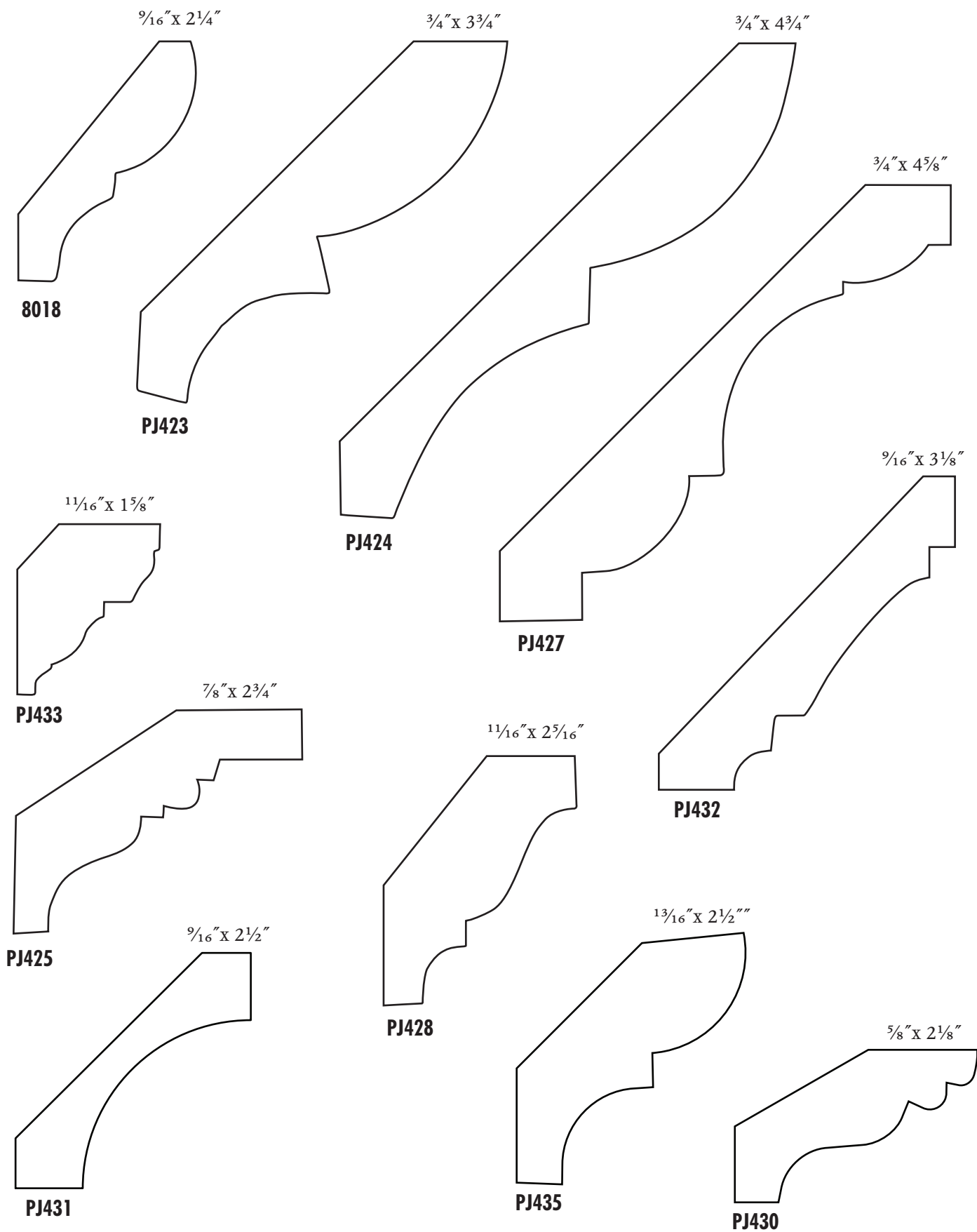

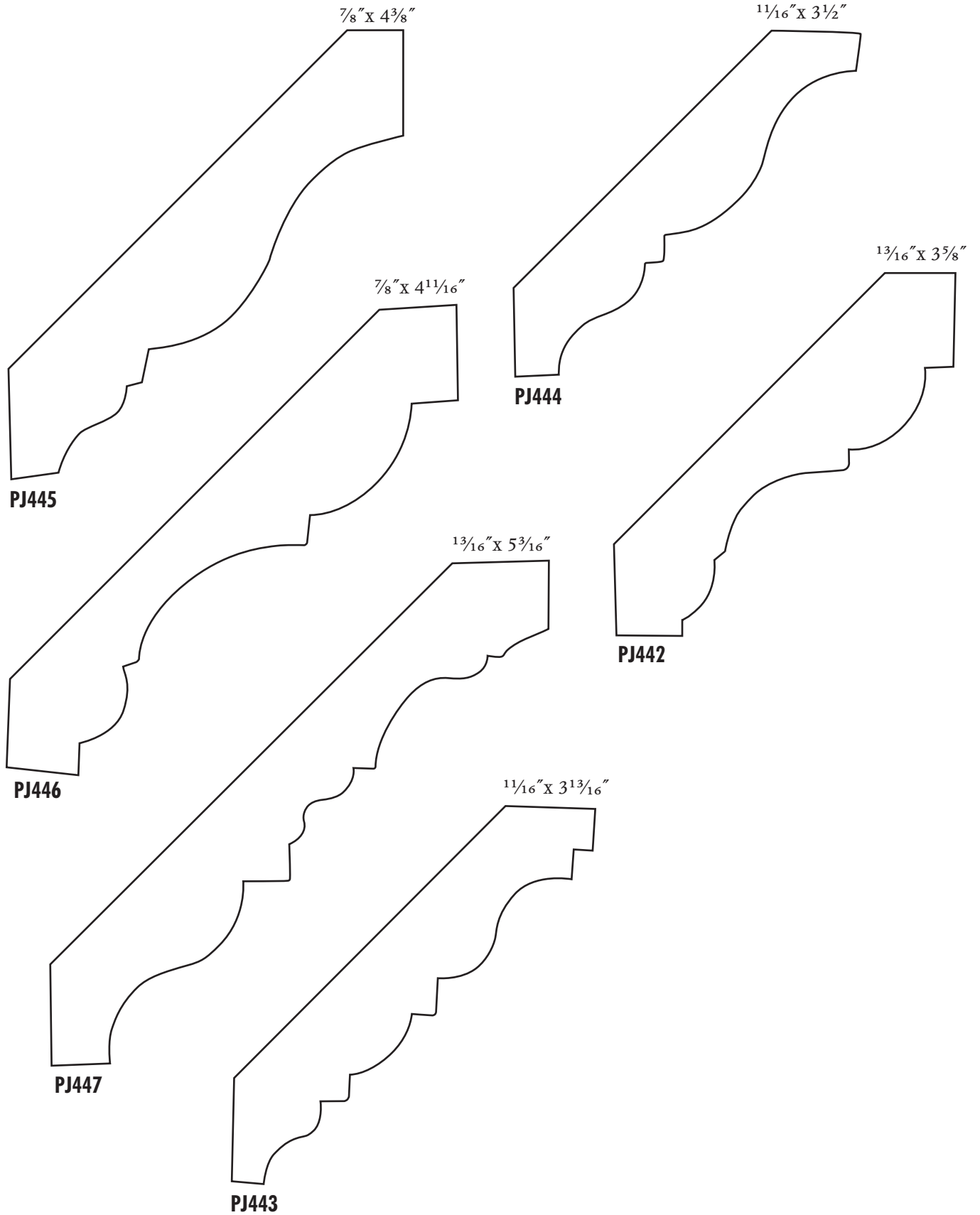

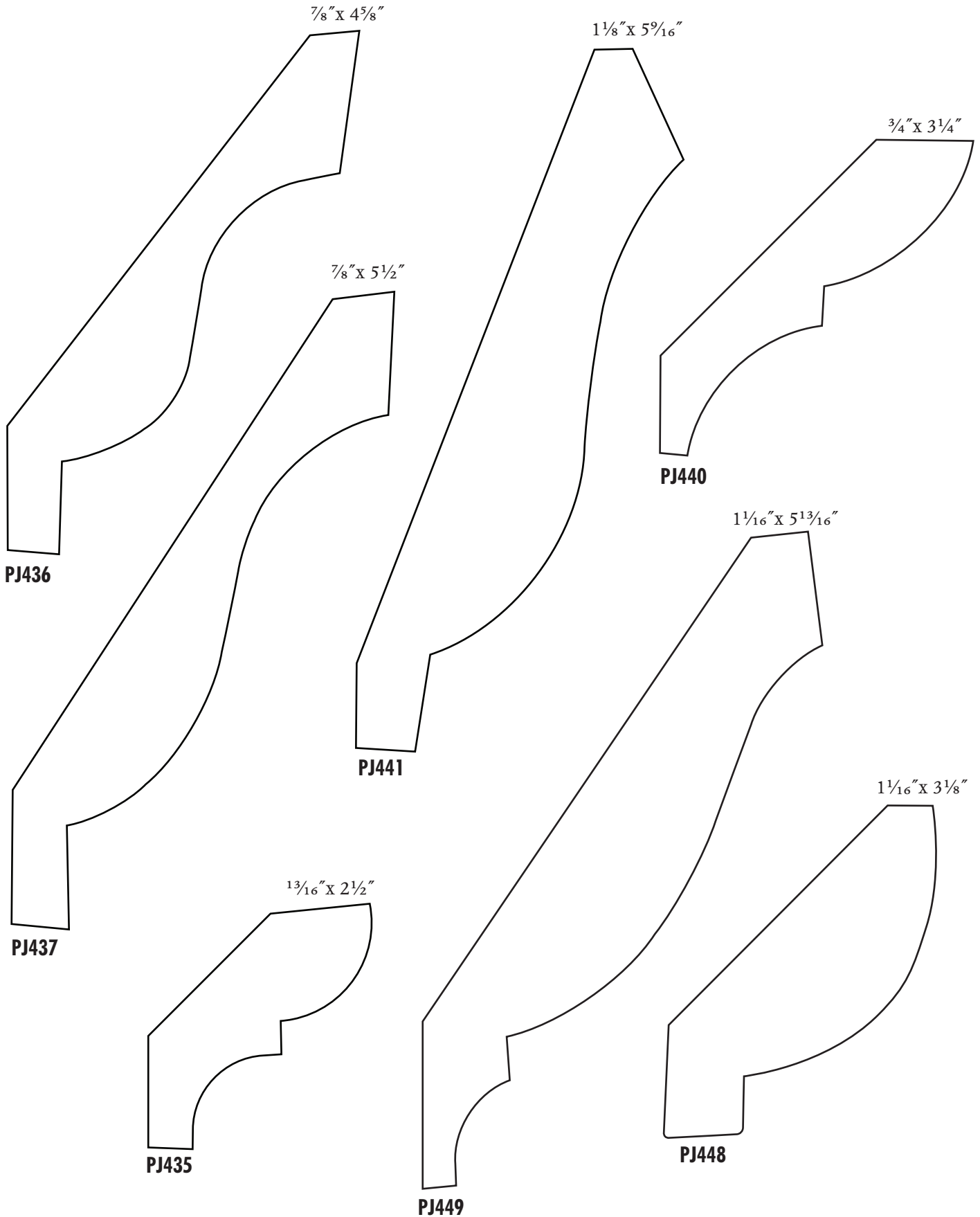

3" x 3 1/4"

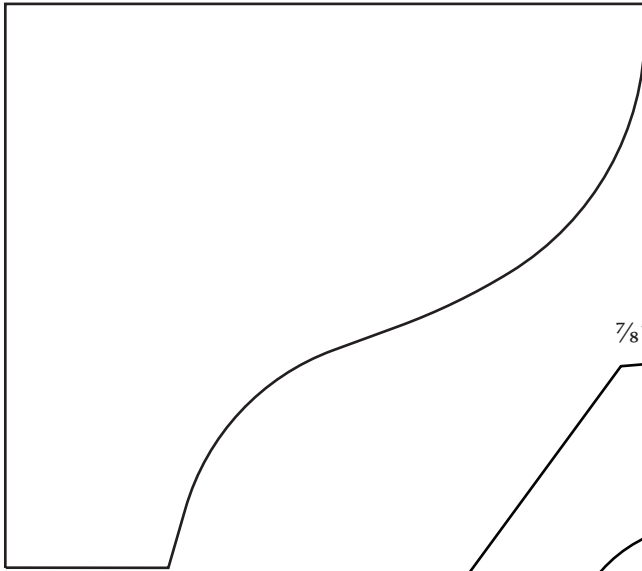

PJ450

7/8" x 7"

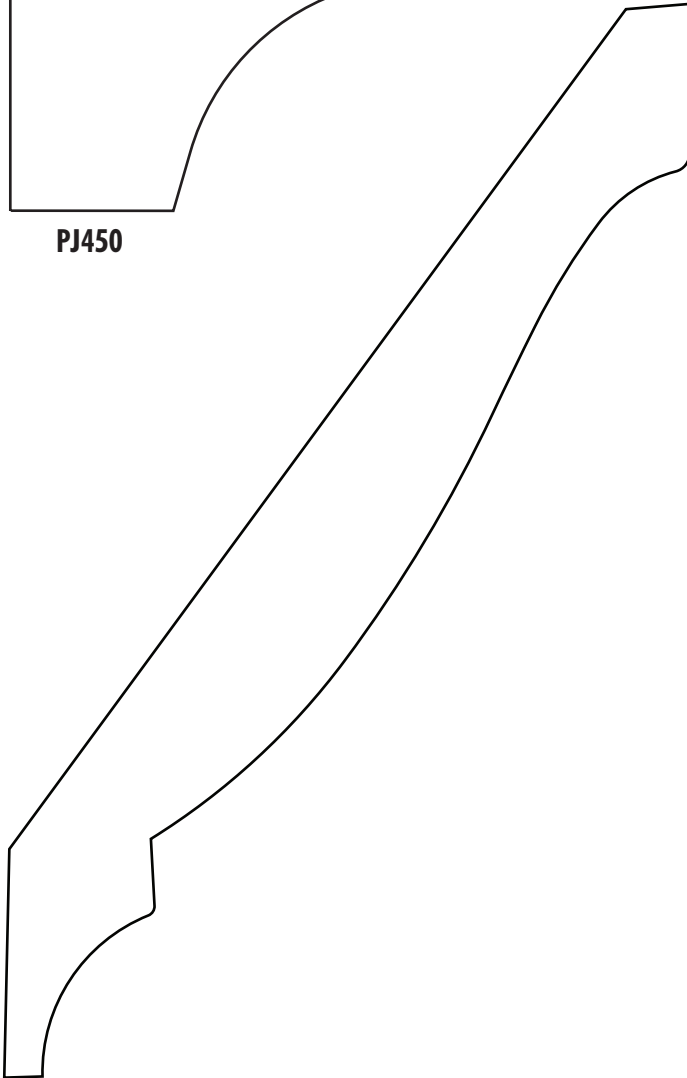

PJ451

1 5/8" x 2 3/4"

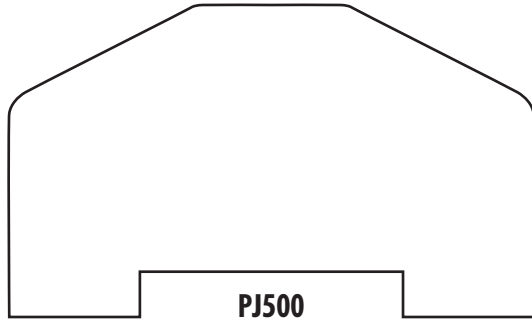

PJ501

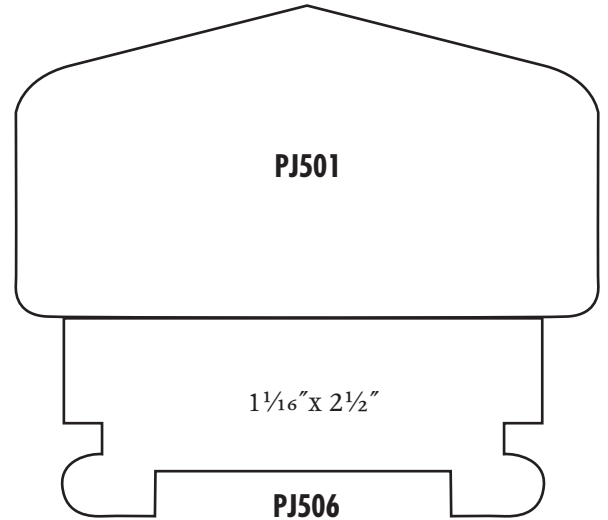

1 1/2" x 3"

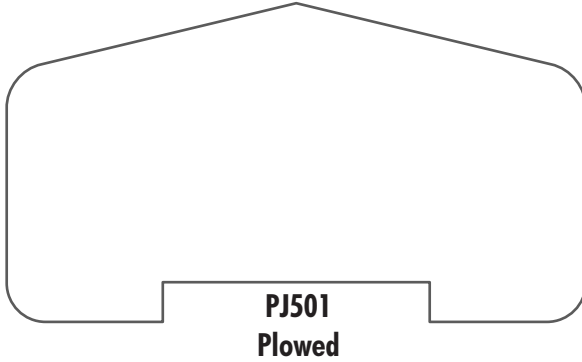

PJ501
No Plow

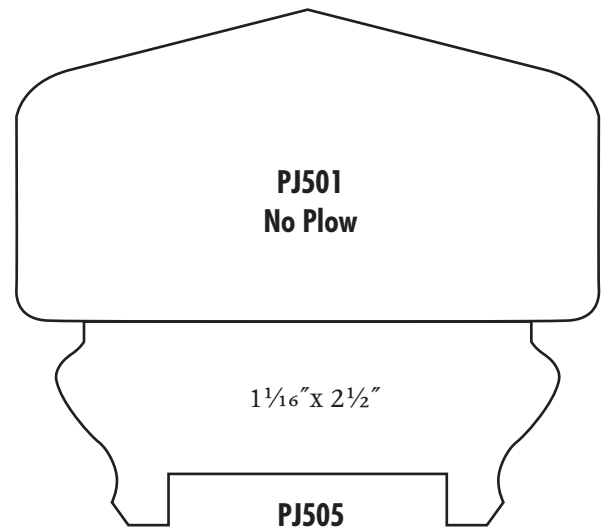

1 1/2" x 3 1/4"

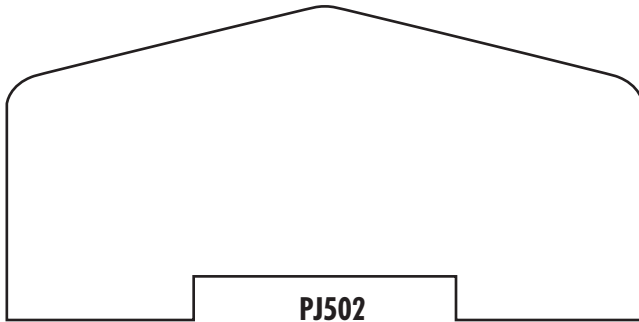

1 1/2" x 2 1/2"

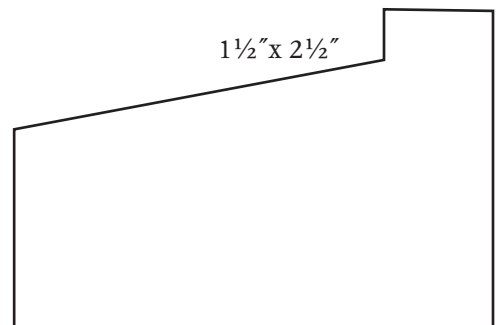

1½" x 5½"

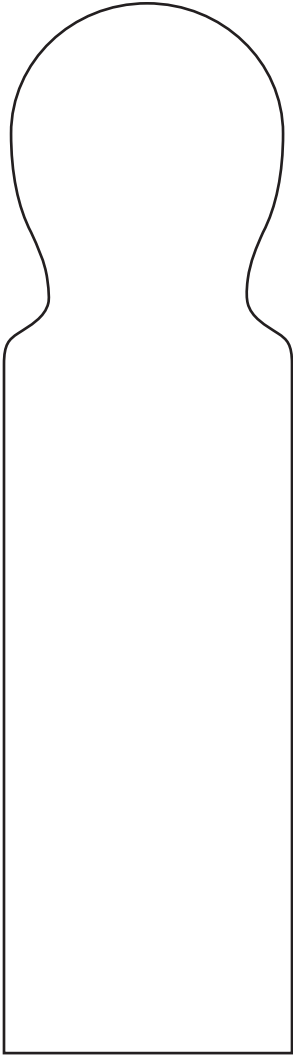

PJ503

1½" x 5½"

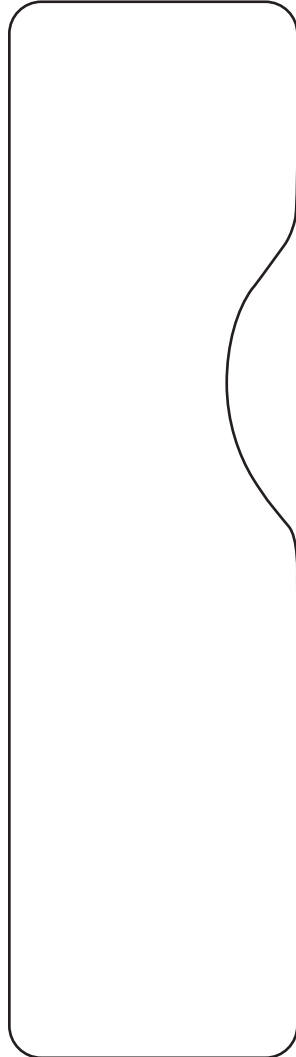

PJ511

1½" x up to 7"

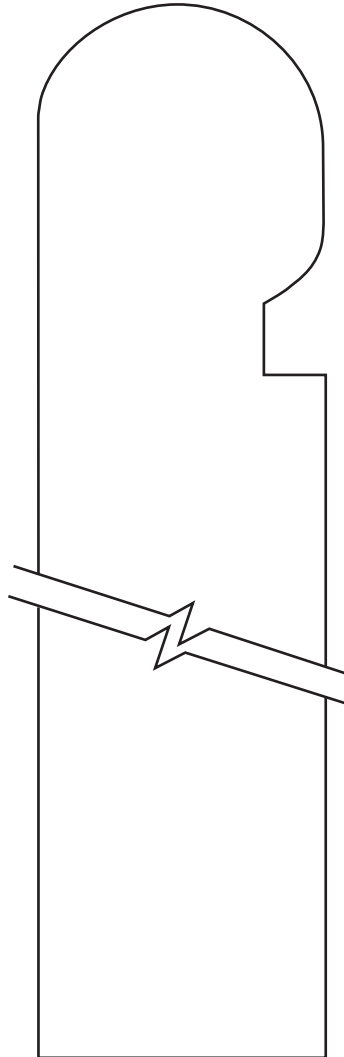

PJ516

1⅝" x 4½"

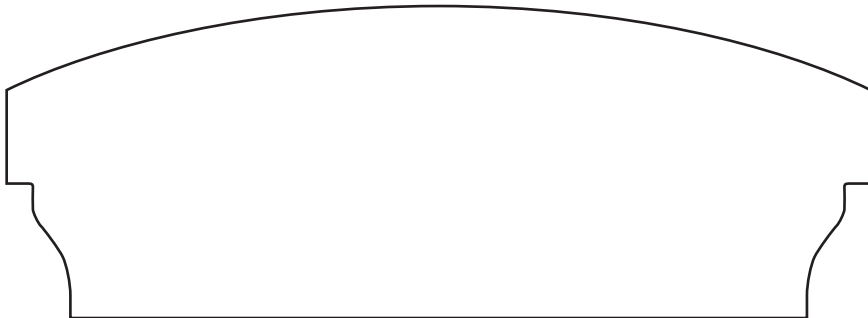

PJ515

3" x 2 1/8"

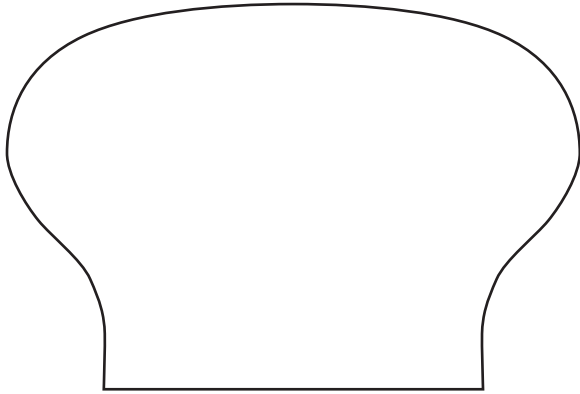

PJ513

1 5/8" x 2 3/4"

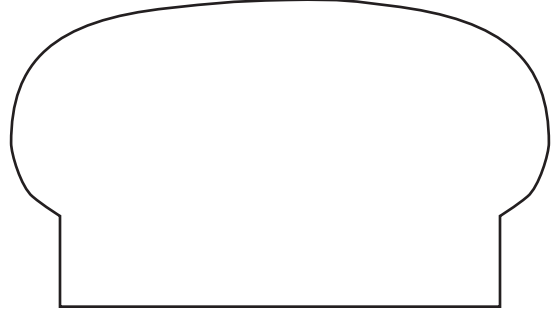

PJ514

3 3/4" x 3 5/8"

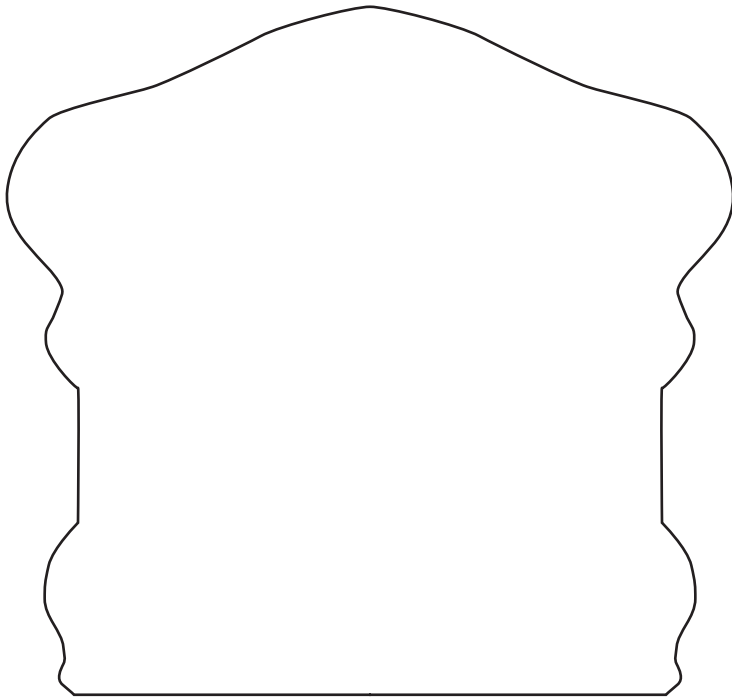

PJ510

2 1/2" x 3 3/4"

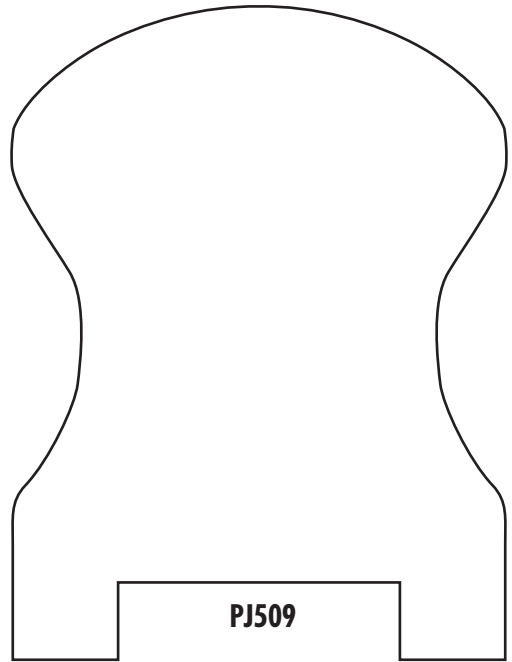

PJ509

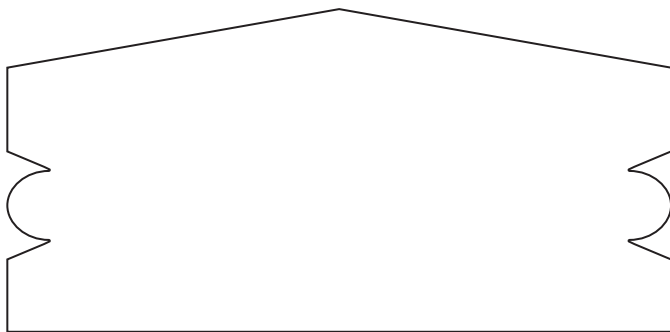

PJ714B (top rail)

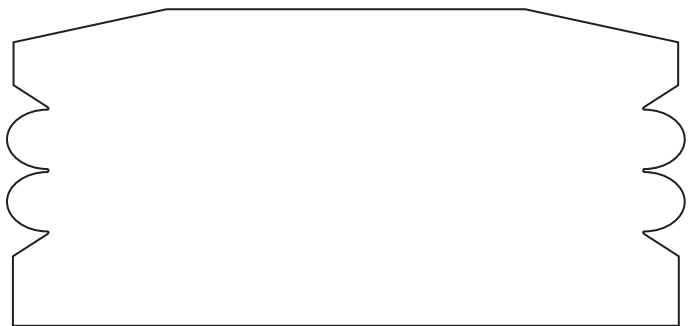

PJ715B (bottom rail)

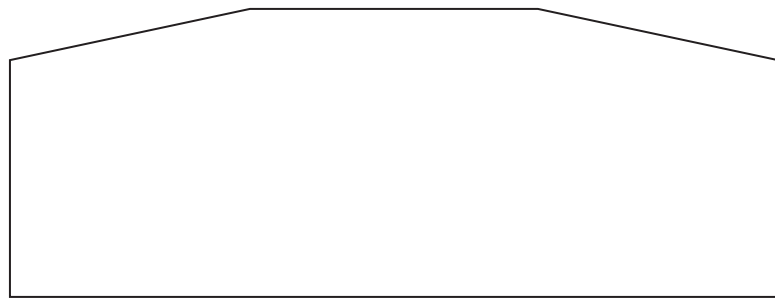
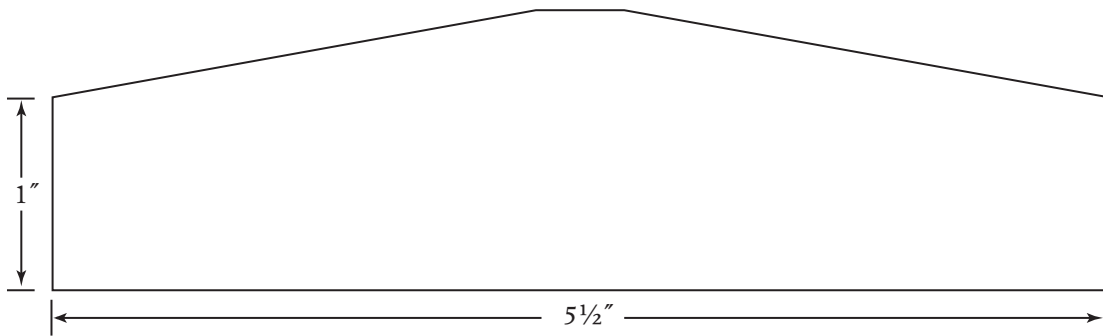
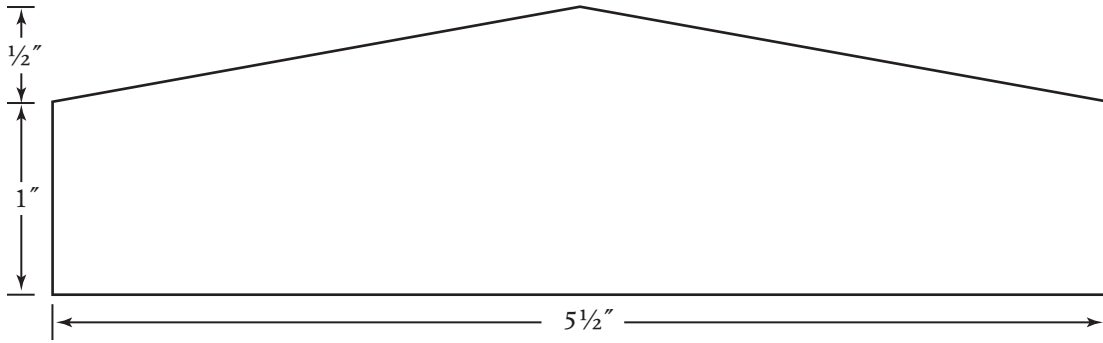

$2\frac{3}{8}'' \times 2\frac{7}{8}''$

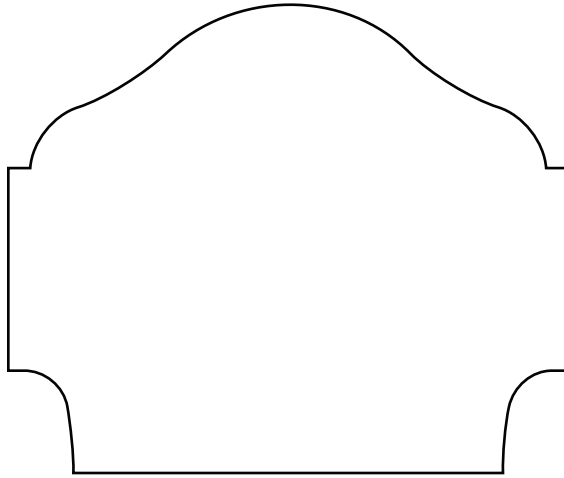

PJ504

$1\frac{1}{16}'' \times 3$

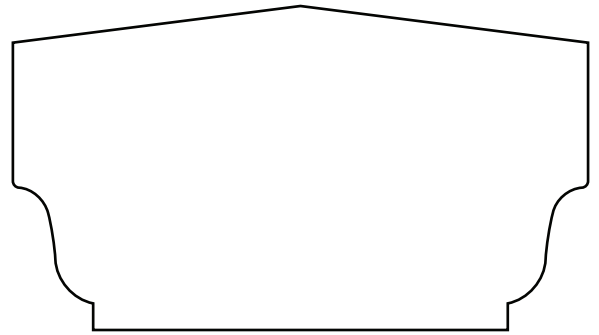

PJ517

$\frac{1}{2}$ " x $1\frac{1}{16}$ "

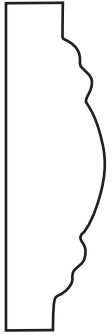

PJ606

$\frac{7}{8}$ " x $2\frac{3}{8}$ "

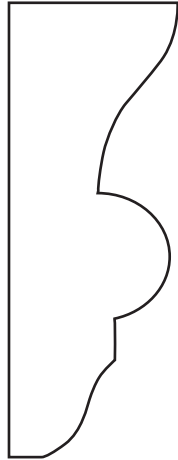

PJ602

$1\frac{1}{4}$ " x $2\frac{3}{4}$ "

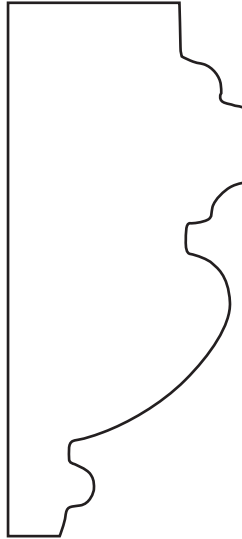

PJ601

$1\frac{1}{16}$ " x $2\frac{1}{2}$ "



8630

$\frac{7}{8}$ " x $3\frac{1}{2}$ "

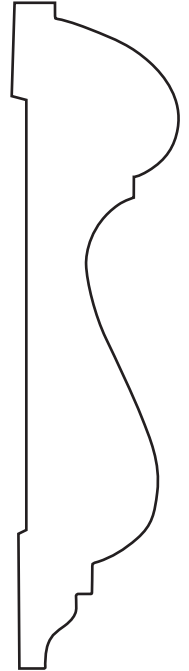

PJ609

$\frac{7}{8}$ " x $2\frac{1}{4}$ "

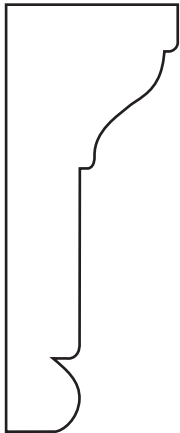

PJ610

$1\frac{1}{8}$ " x $1\frac{1}{2}$ "

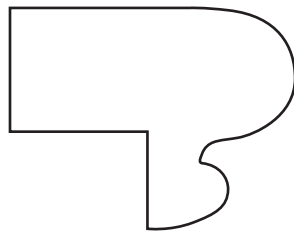

PJ608

Astragal
 $1\frac{1}{16}$ " x $1\frac{3}{4}$ "



8171

$1\frac{1}{16}$ " x $1\frac{3}{4}$ "



PJ108

$1\frac{1}{2}$ " x $3\frac{1}{2}$ "

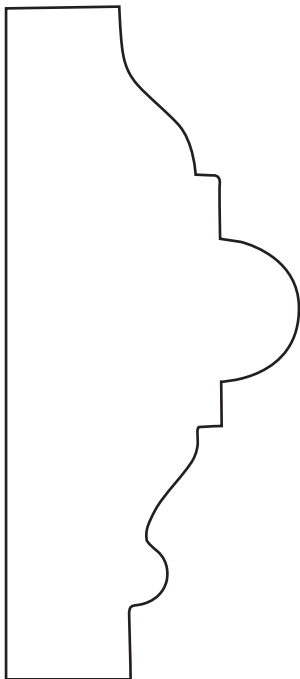

PJ603

$1\frac{1}{4}$ " x $3\frac{1}{2}$ "

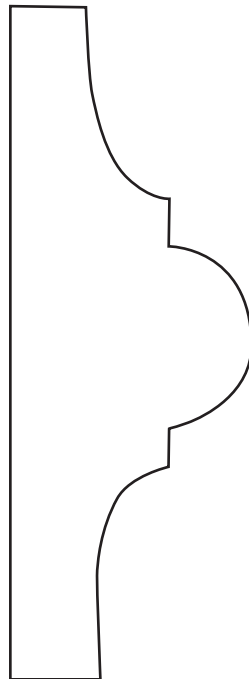

PJ604

$1\frac{1}{16}$ " x $2\frac{1}{2}$ "

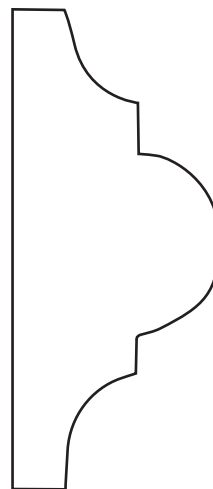

PJ607

$1\frac{1}{16}$ " x $3\frac{1}{16}$ "

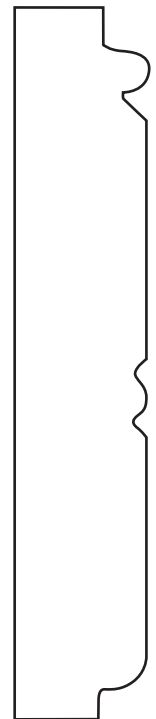

PJ605

1 3/8" x 3"

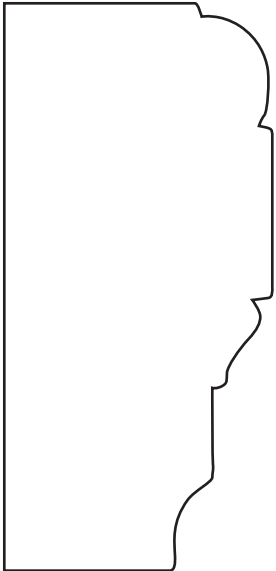

PJ611

1" x 3 1/2"

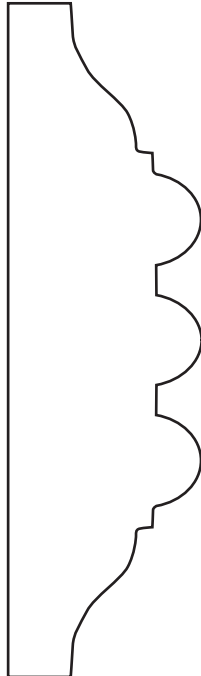

PJ612

3/4" x 2 1/2"

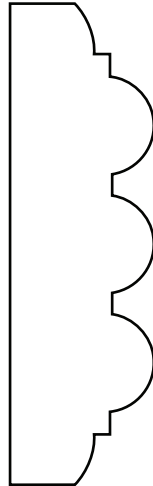

PJ612A

1" x 3"

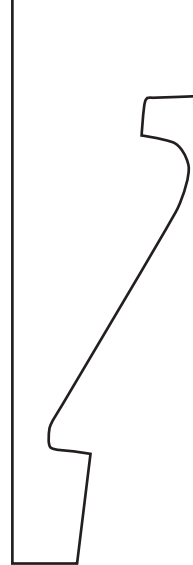

PJ613

1 3/16" x 4"

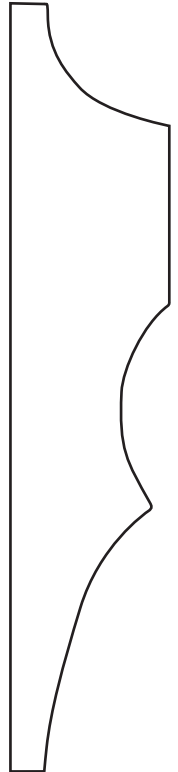

PJ614

1 1/16" x 2"

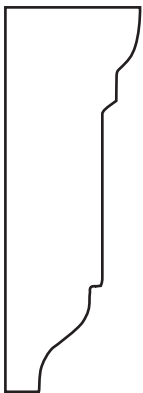

PJ615

7/8" x 4"

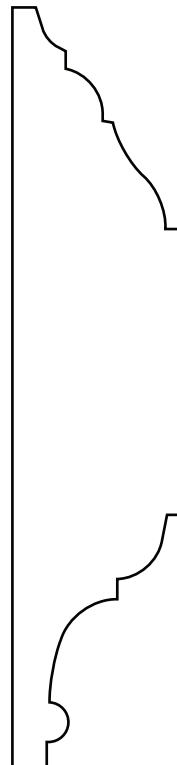

PJ619

3/4" x 3 1/8"

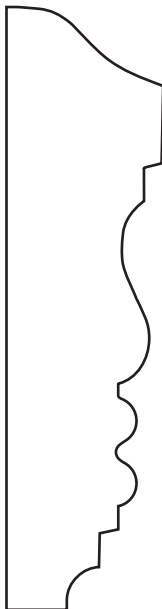

PJ616

3/4" x 2 7/8"



PJ618

3/4" x 3"

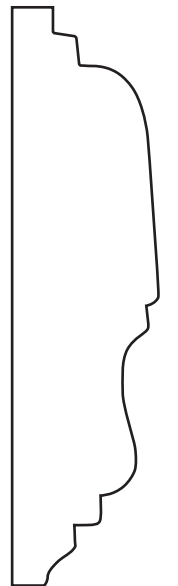

PJ617

1 1/16" x 1 1/4"

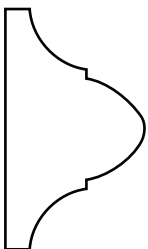

PJ600

$\frac{7}{8}$ " X $2\frac{1}{8}$ "

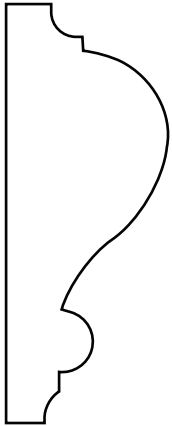

PJ620

$\frac{9}{16}$ " X $2\frac{5}{8}$ "

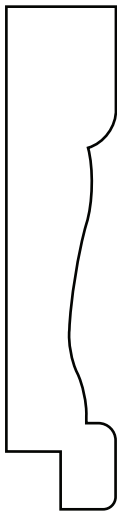

PJ625

$\frac{9}{16}$ " X $2\frac{3}{4}$ "

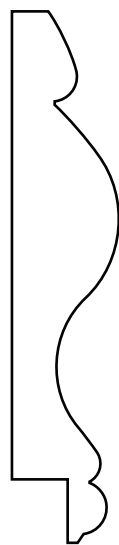

PJ623

$\frac{5}{8}$ " X $2\frac{3}{8}$ "

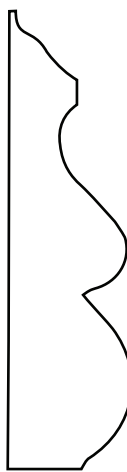

PJ624

$1\frac{3}{16}$ " X $1\frac{3}{8}$ "

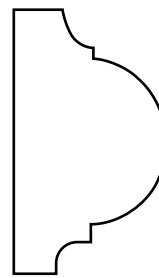

PJ621

$\frac{3}{4}$ " X 2"

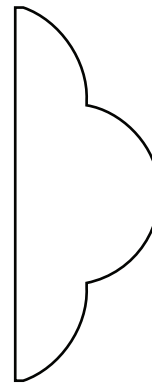

PJ628

$\frac{3}{4}$ " X $2\frac{5}{8}$ "

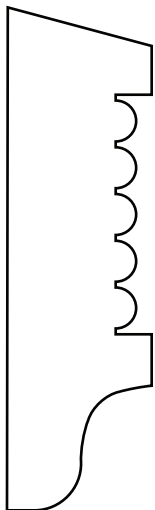

PJ622

$1\frac{1}{4}$ " X $2\frac{7}{16}$ "

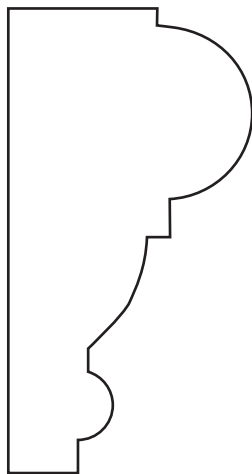

PJ627

$1\frac{1}{16}$ " X $2\frac{1}{4}$ "



PJ626

2¼" x 1⅛"

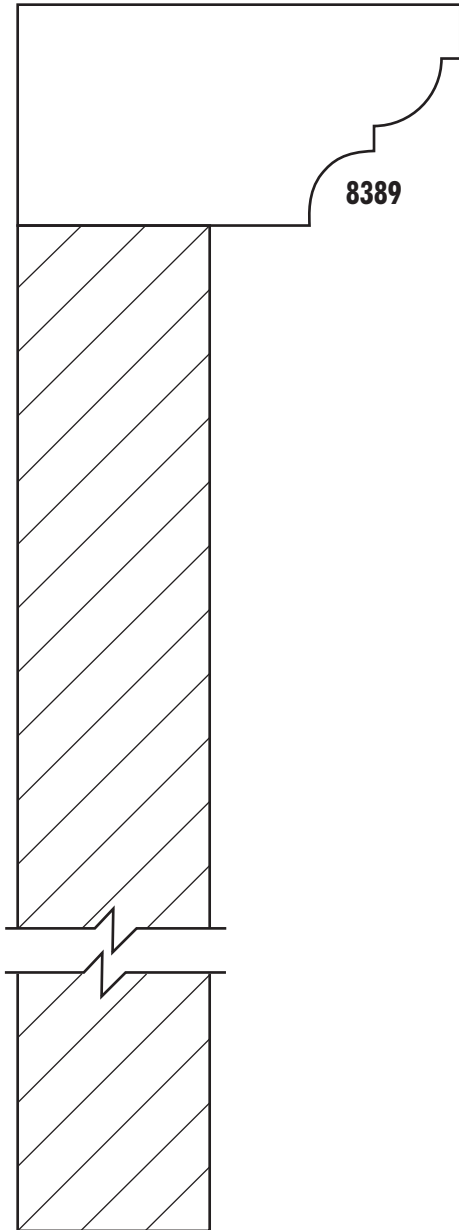

1⅜" x 1⅜"

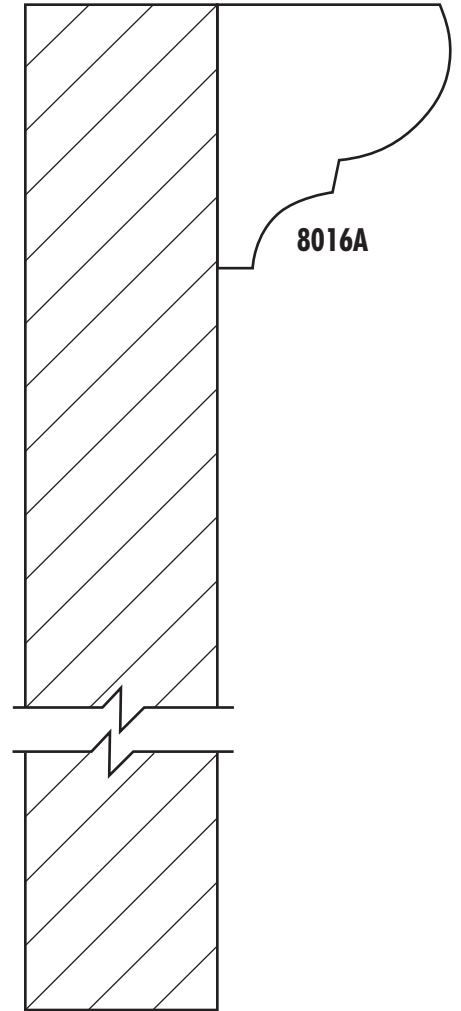
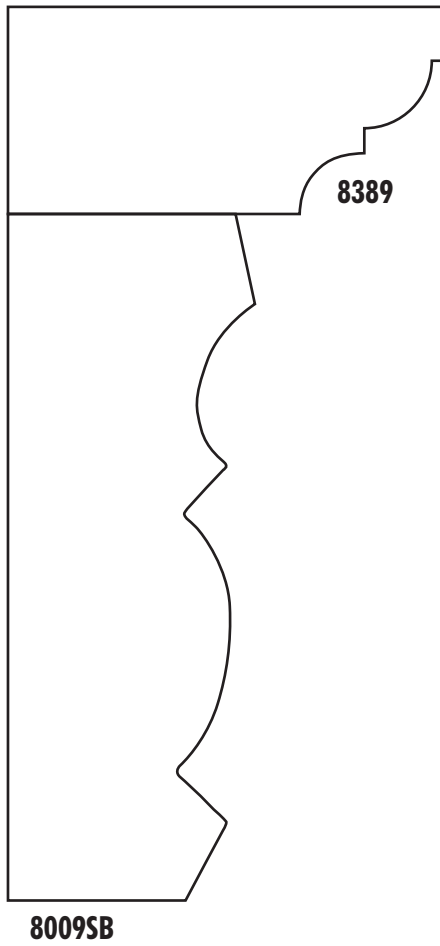

1⅜" x 1¾"

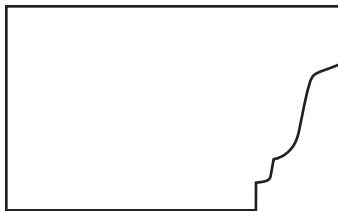

1⅜" x 1⅜"



1⅜" x 2⅜"

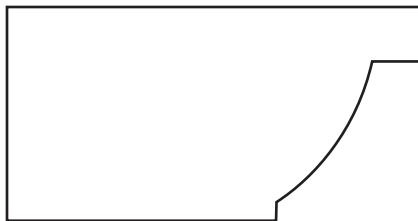

2⅜" x 1⅝"

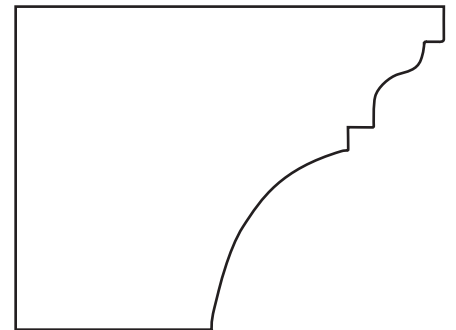



3/16" Bead



1/4" Custom Bead

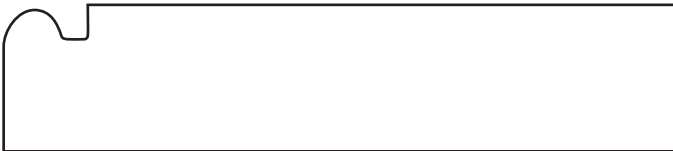

5/16" Bead

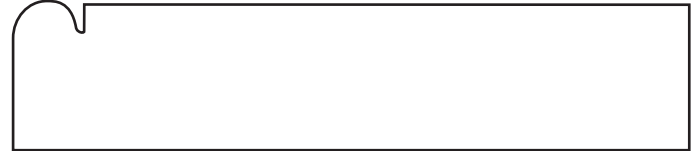

3/8" Custom Bead



3/8" Bead

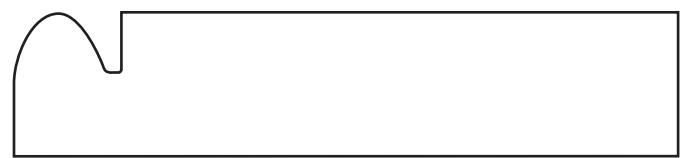

1/2" Custom Bead

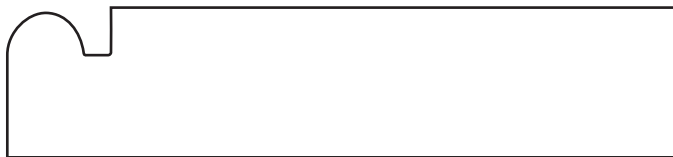

7/16" Bead



PJ735

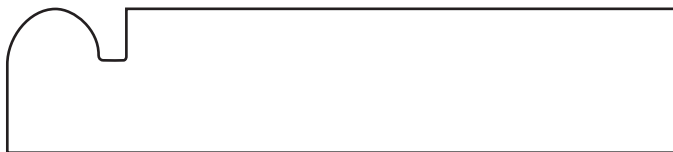

1/2" Bead



PJ714

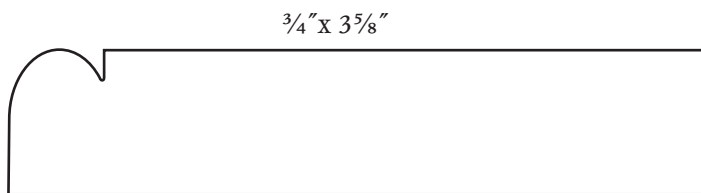

PJ292



PJ715

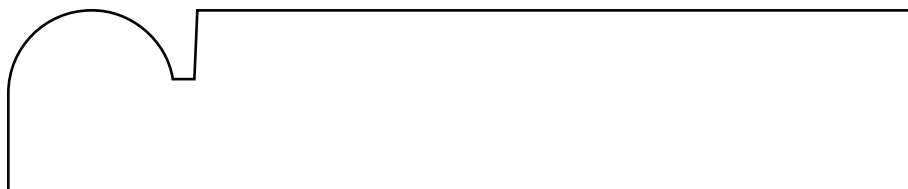

7/8" Bead

PJ Carrier Lumber

PANELING 1

Paneling may require both planer and molder

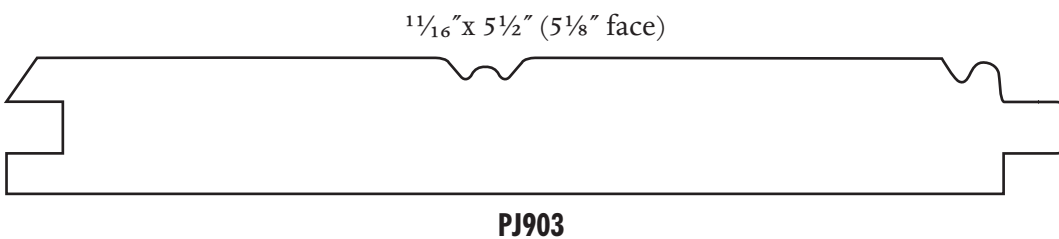
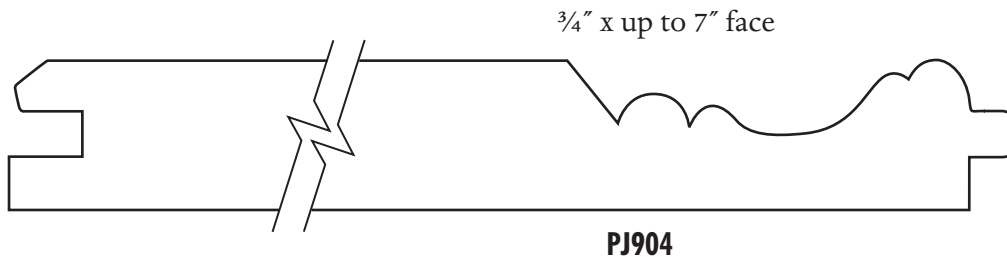
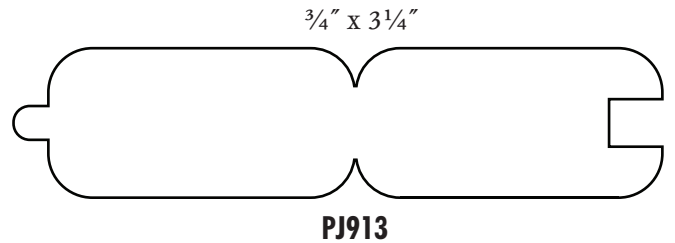
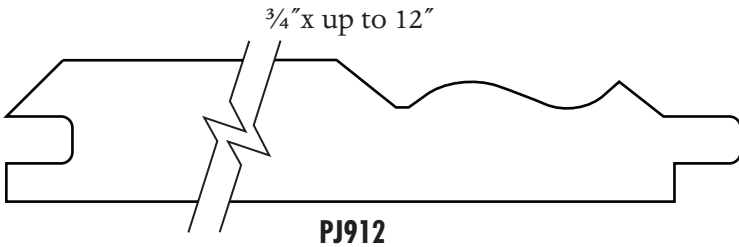
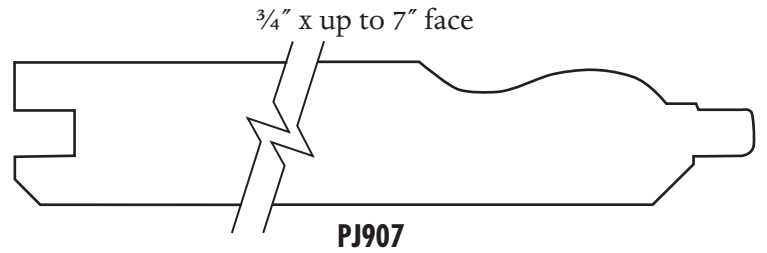
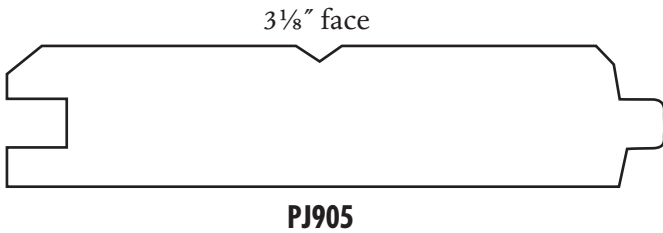
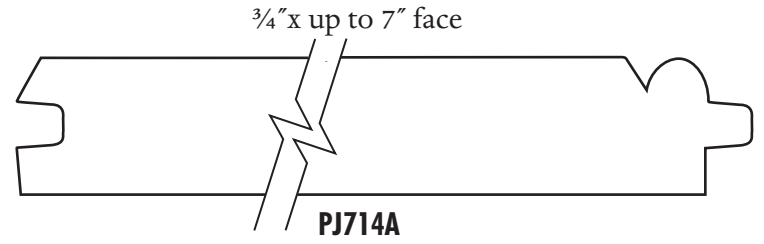
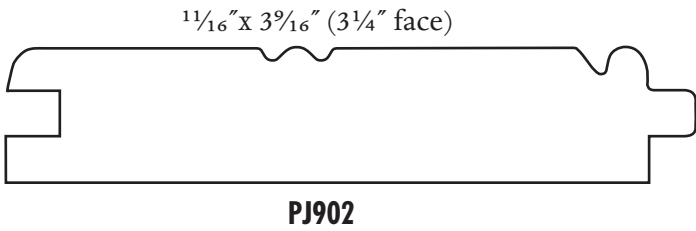
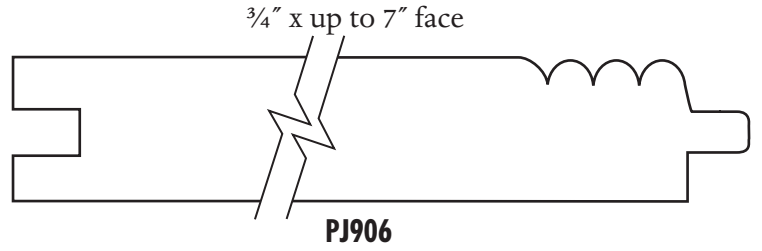
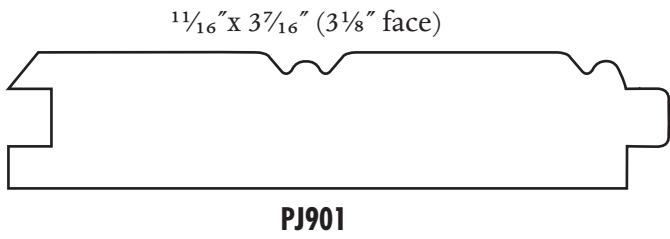

Paneling may require both planer and molder

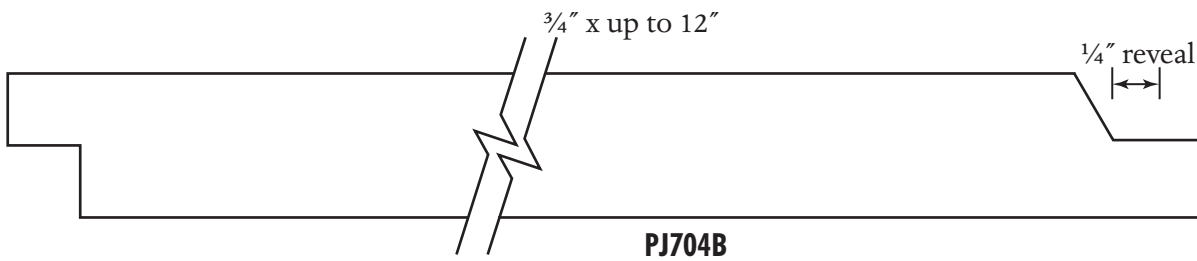
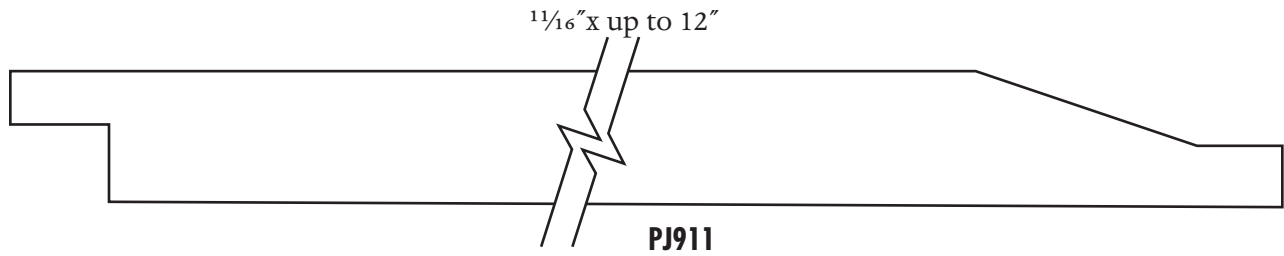
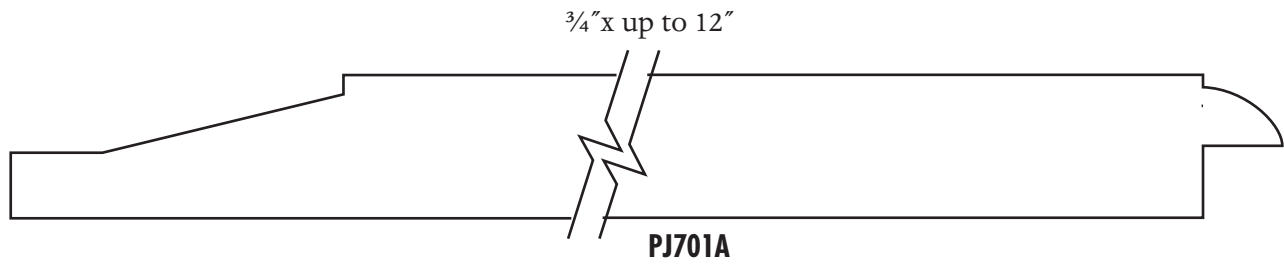
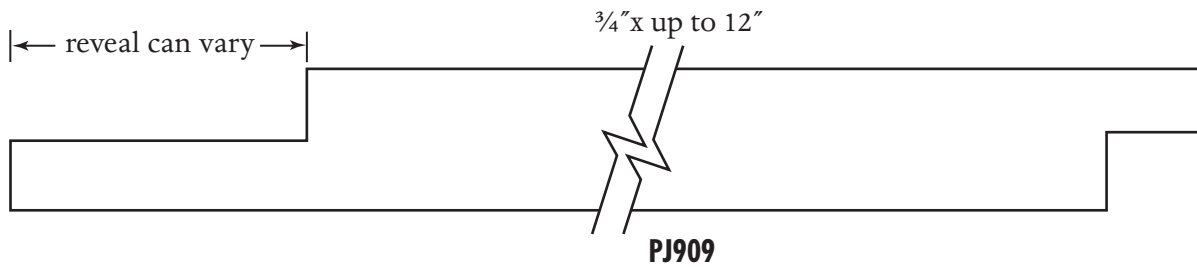
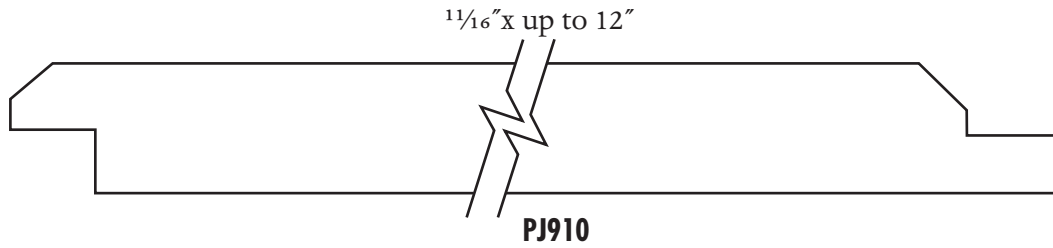

Paneling may require both planer and molder

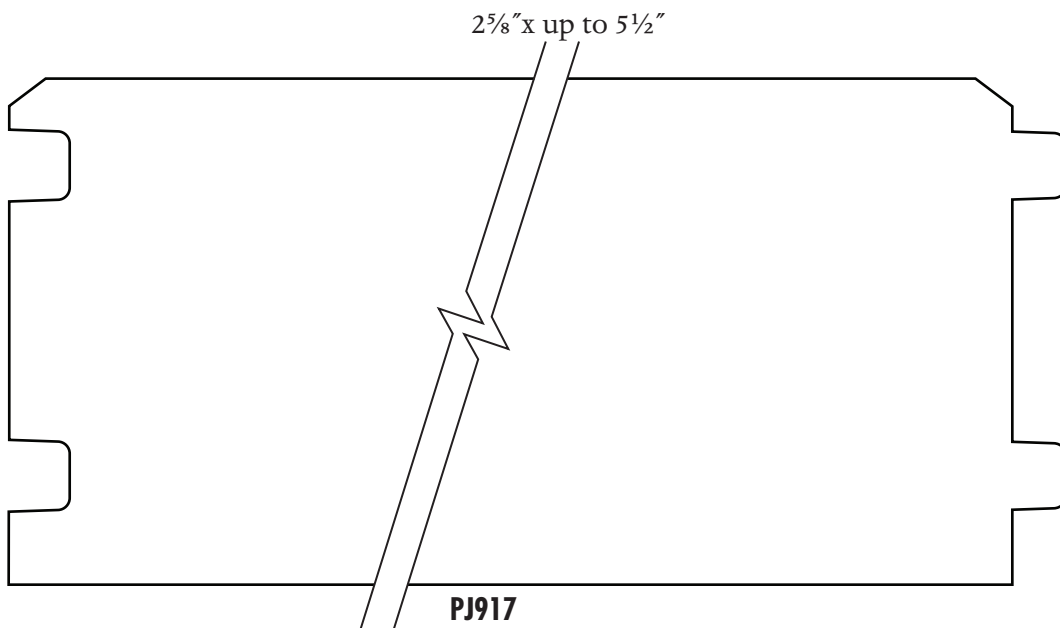
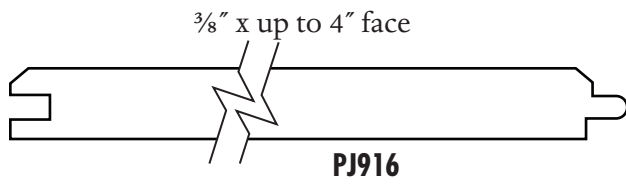
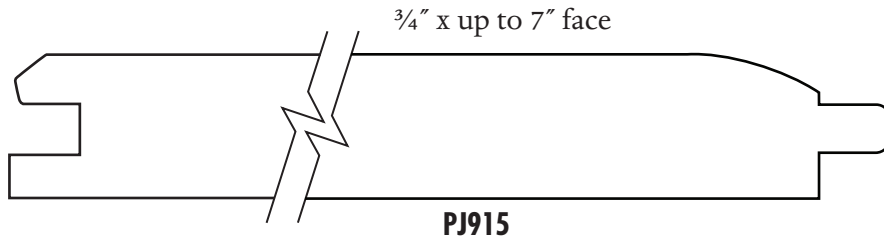

These are examples of flute sizes and spacing.
Choose one or design your own. Specify thickness.

1/2" Flute

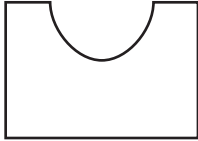

5/8" Flute

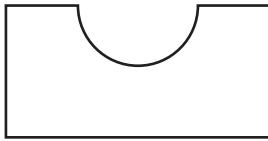

3/4" Flute

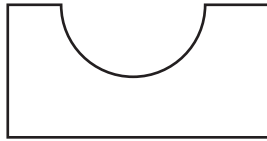

1" Flute

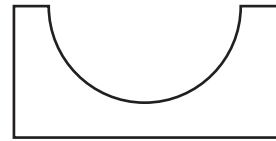

5/8 x 1 3/4" Flute

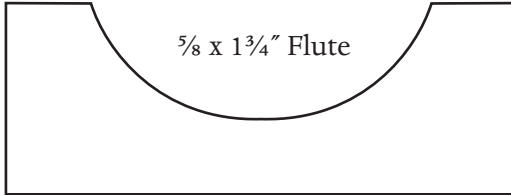

PJ511

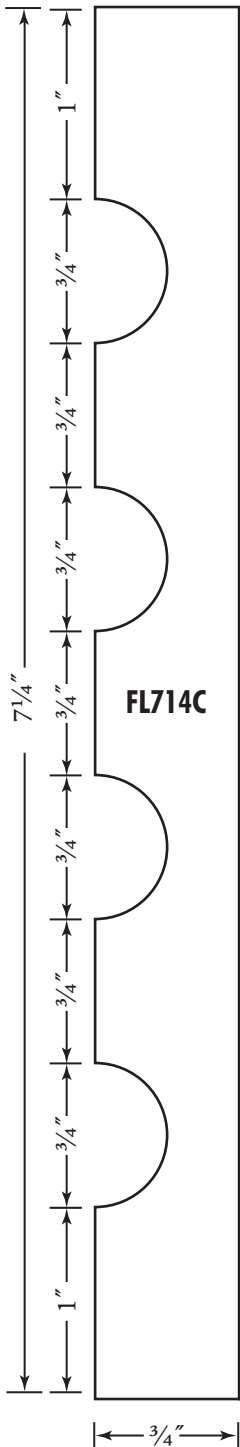

FL714C

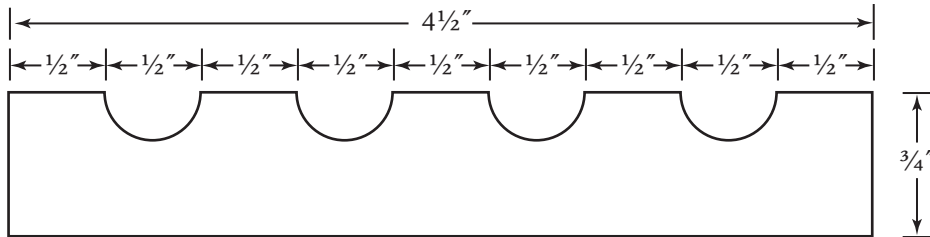

FL412A

1/2" flute with 1/2" spacing

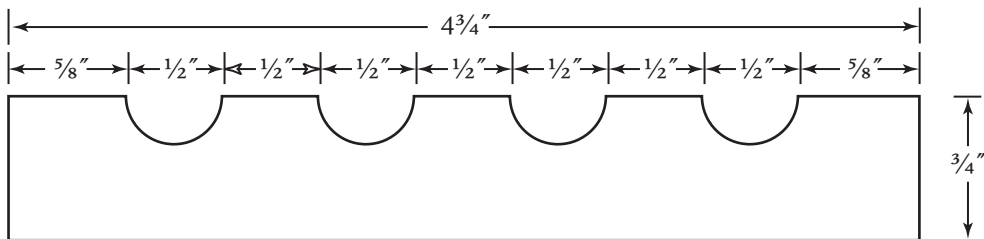

FL434A

1/2" flute with 1/2" spacing

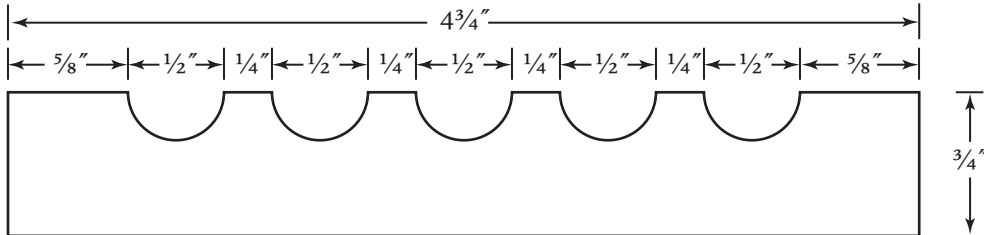

FL434B

1/2" flute with 1/4" spacing

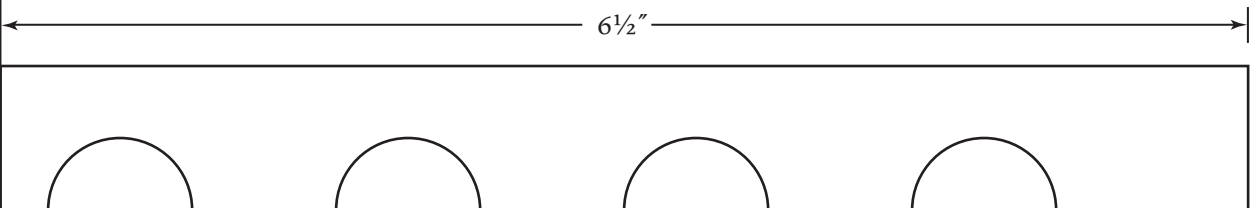

3/4" Fluted corner

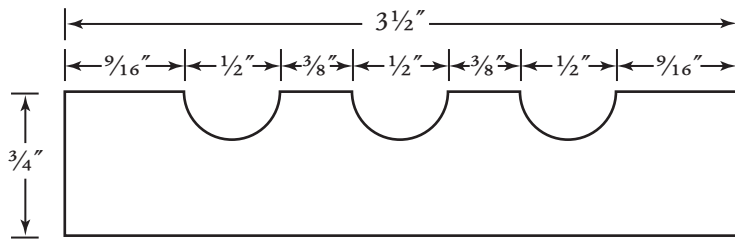

FL312A 1/2" flutes, 3/8" spacing, 3 1/2" wide

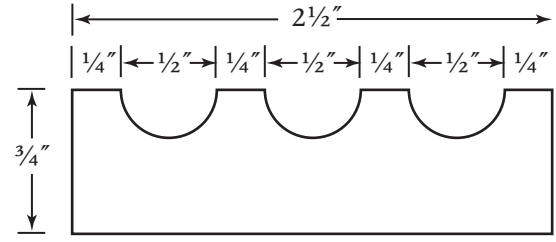

FL212A 1/2" flutes, 1/4" spacing, 2 1/2" wide

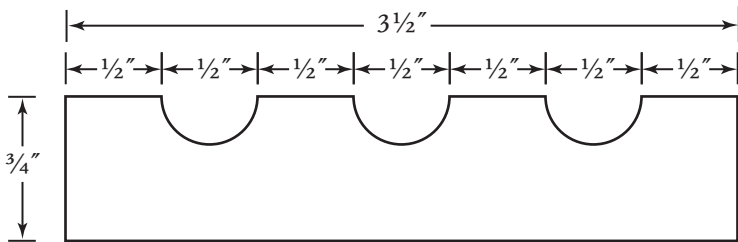

FL312B 1/2" flutes, 1/2" spacing, 3 1/2" wide

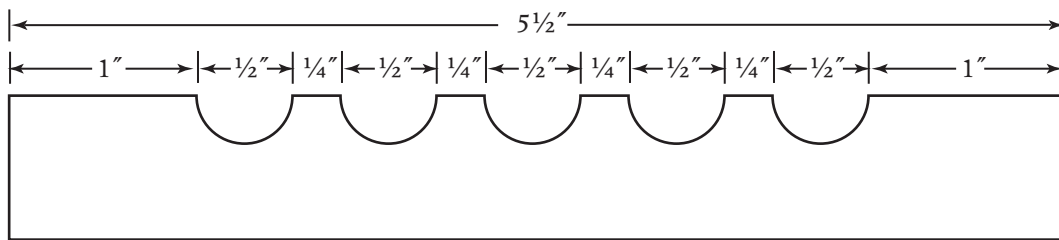

FL512A Five 1/2" flutes, 1/4" spacing, 5 1/2" wide

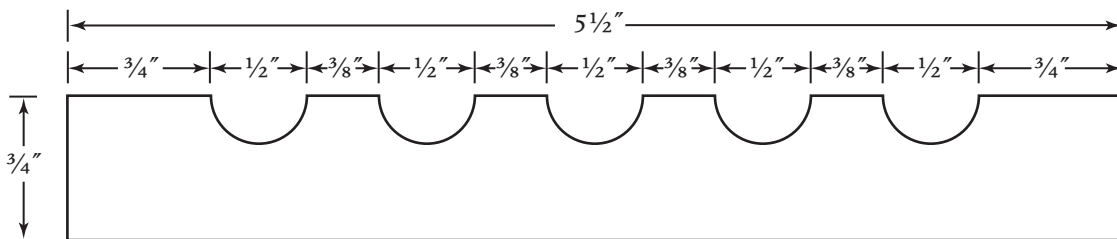

FL512B Five 1/2" flutes, 3/8" spacing, 5 1/2" wide

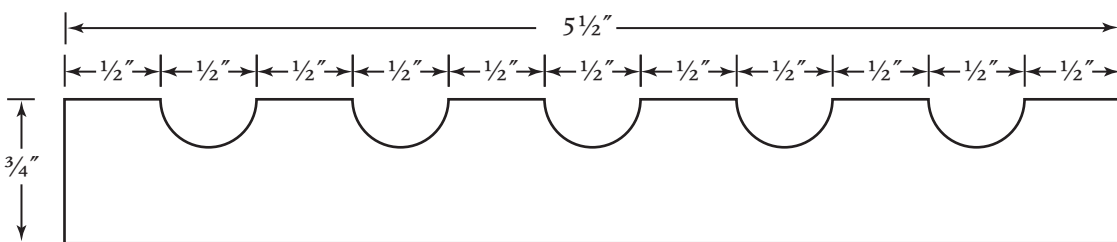

FL512C Five 1/2" flutes, 1/2" spacing, 5 1/2" wide

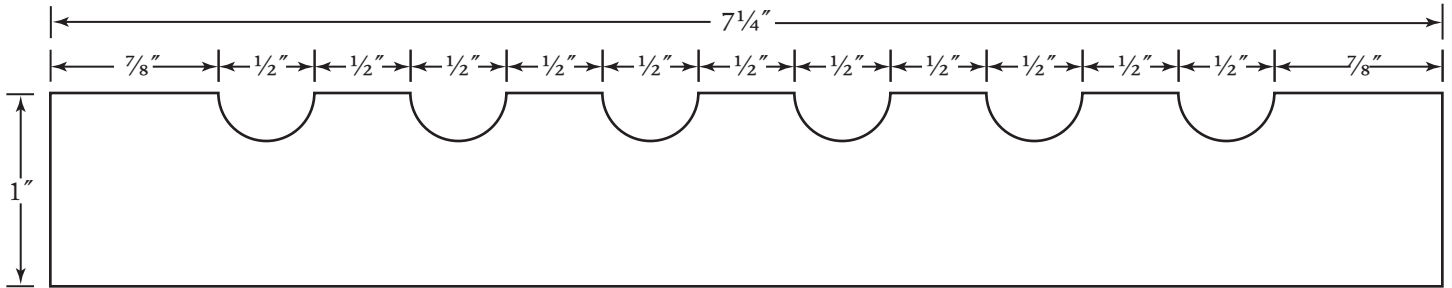

FL714A Six 1/2" flutes, 1/2" spacing, 7 1/4" wide

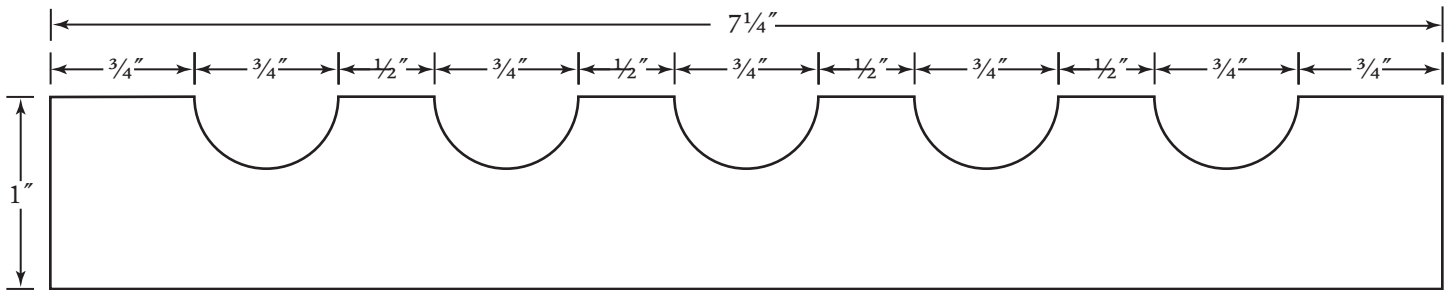

FL714B Five 3/4" flutes, 1/2" spacing, 7 1/4" wide

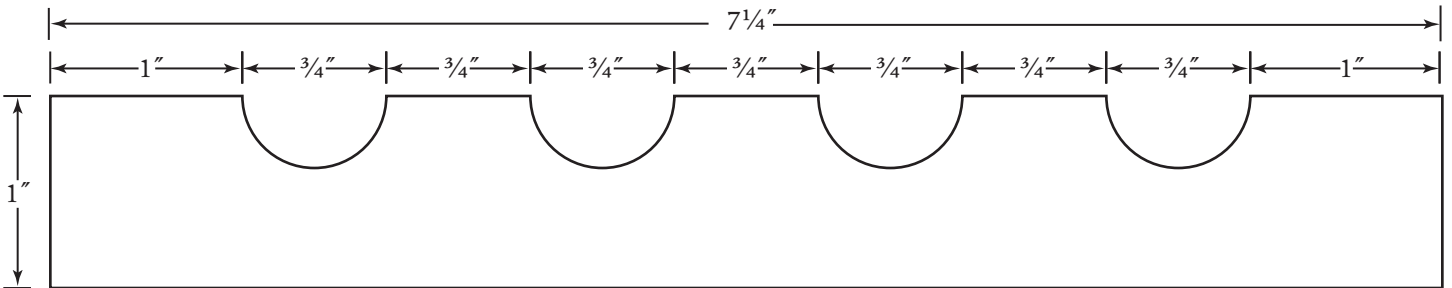

FL714C Four 3/4" flutes, 3/4" spacing, 7 1/4" wide

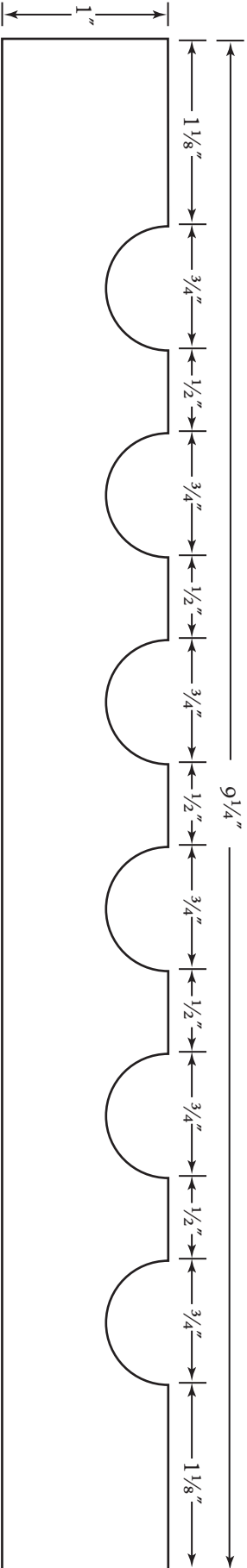

FL914C Six 3/4" flutes, 1/2" spacing, 9 1/4" wide

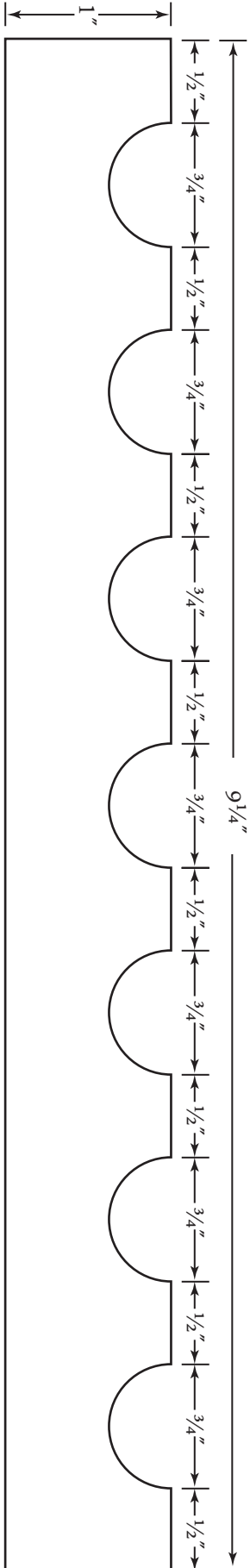

FL914B Seven 3/4" flutes, 1/2" spacing, 9 1/4" wide

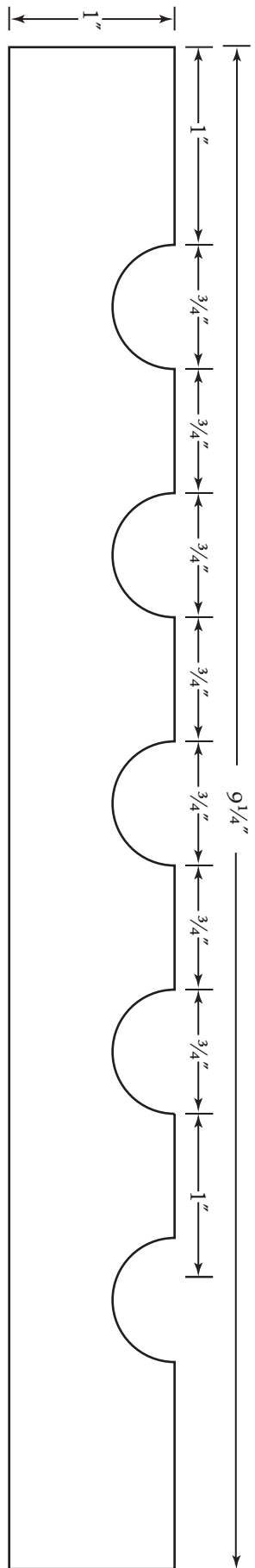

FL914A Six 3/4" flutes, 3/4" spacing, 9 1/4" wide

$\frac{3}{4}'' \times 3\frac{1}{2}''$

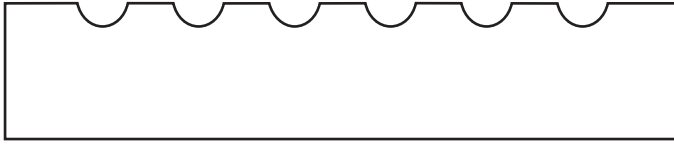

PJ200

$\frac{3}{4}'' \times 3\frac{1}{2}''$

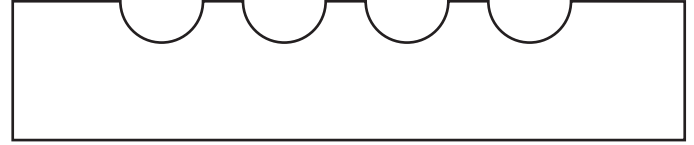

PJ207

$\frac{3}{4}'' \times 4\frac{1}{8}''$

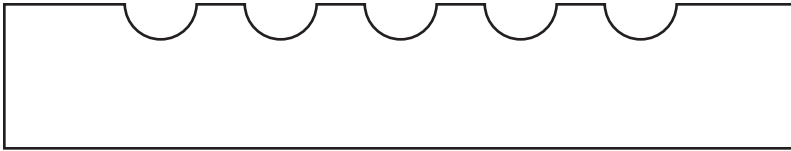

PJ210

$1\frac{1}{16}'' \times 3\frac{7}{8}''$

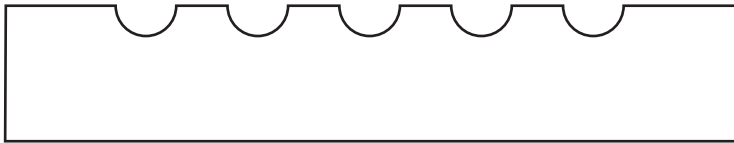

PJ2002

$\frac{3}{4}'' \times 4\frac{3}{4}''$

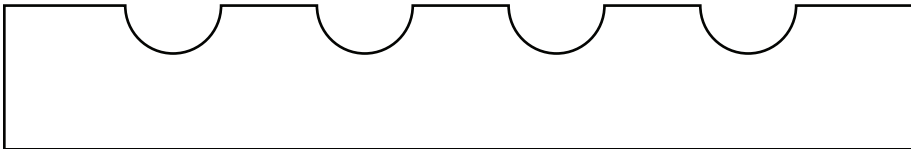

PJ226

$\frac{3}{4}'' \times 5\frac{1}{2}''$

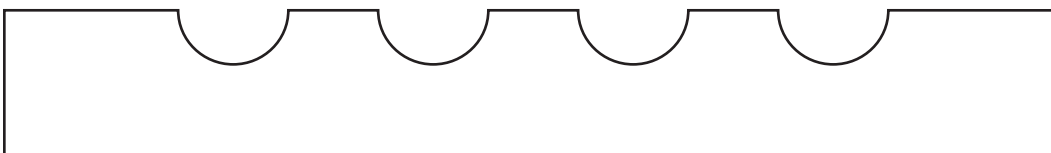

PJ206

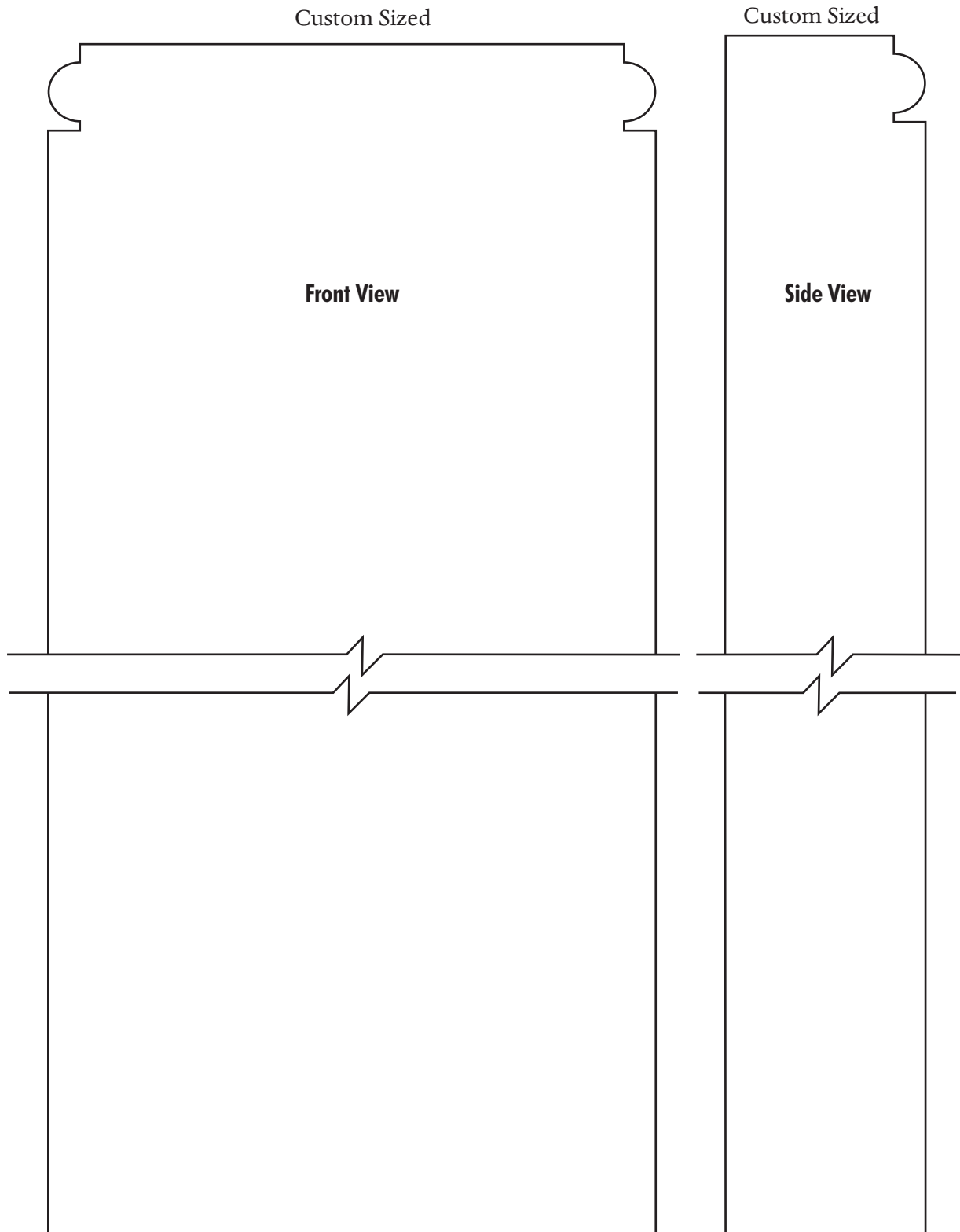

Quarter Rounds

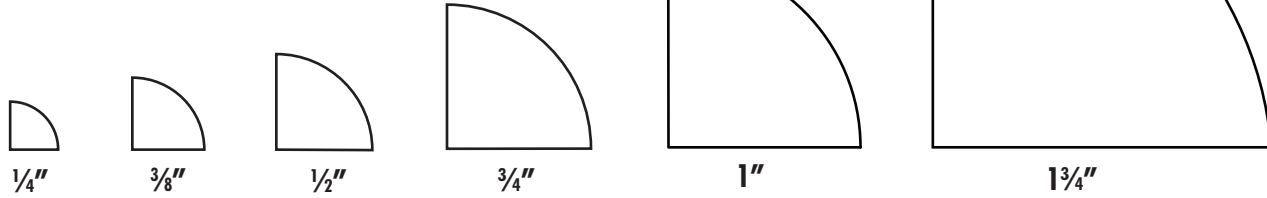

Quarter Round Overs (specify number and placement of corner radius)

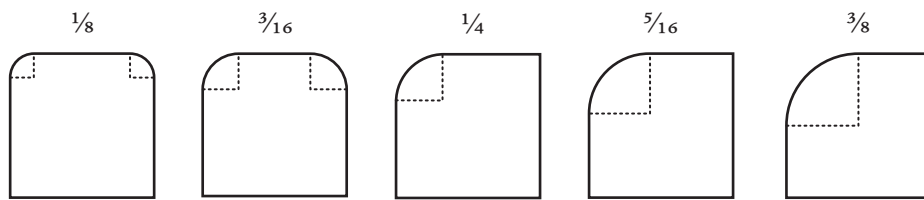

Half Rounds

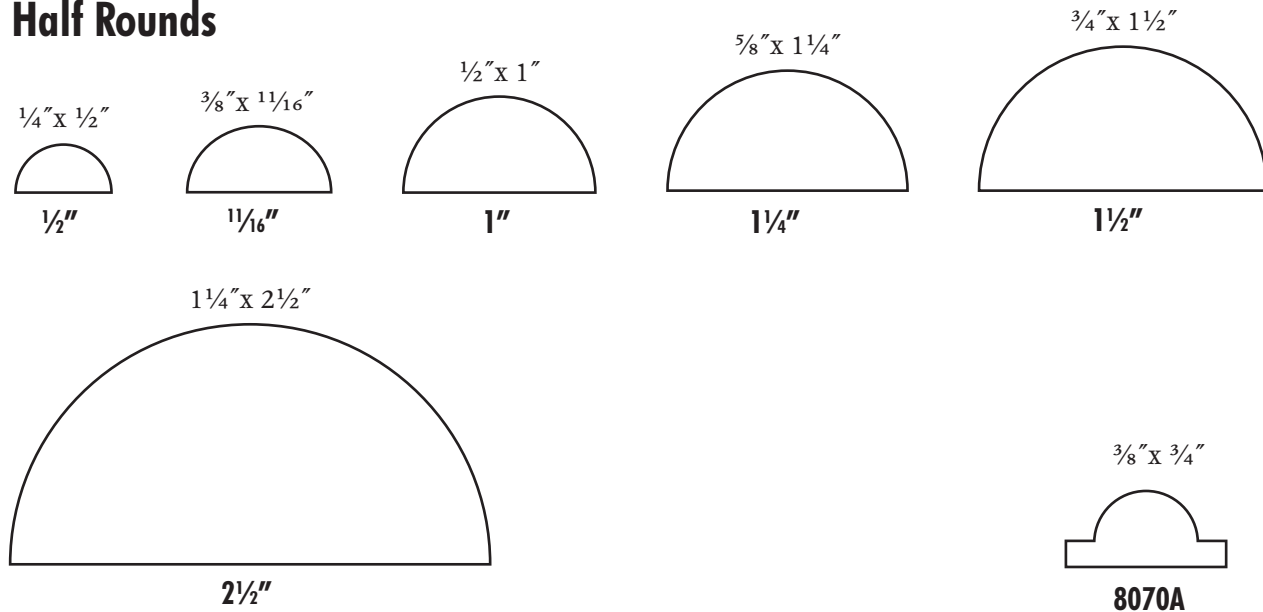

Options

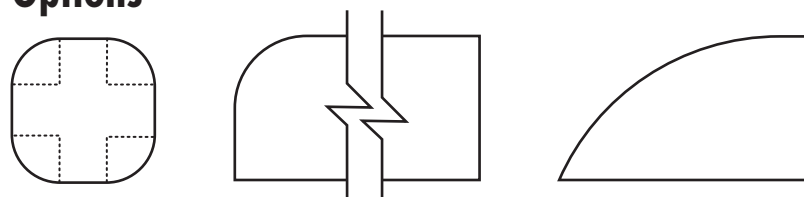

SCOTIAS

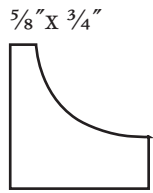

8062

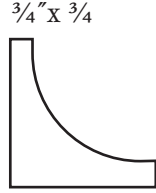

PJ719

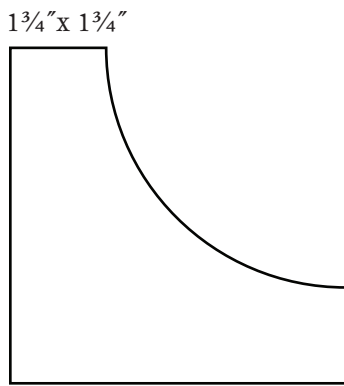

PJ431A

NOSING

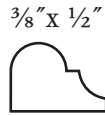

8575

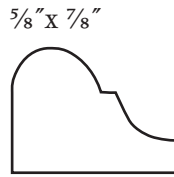

PJ130

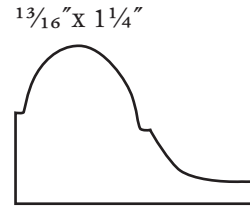

PJ132

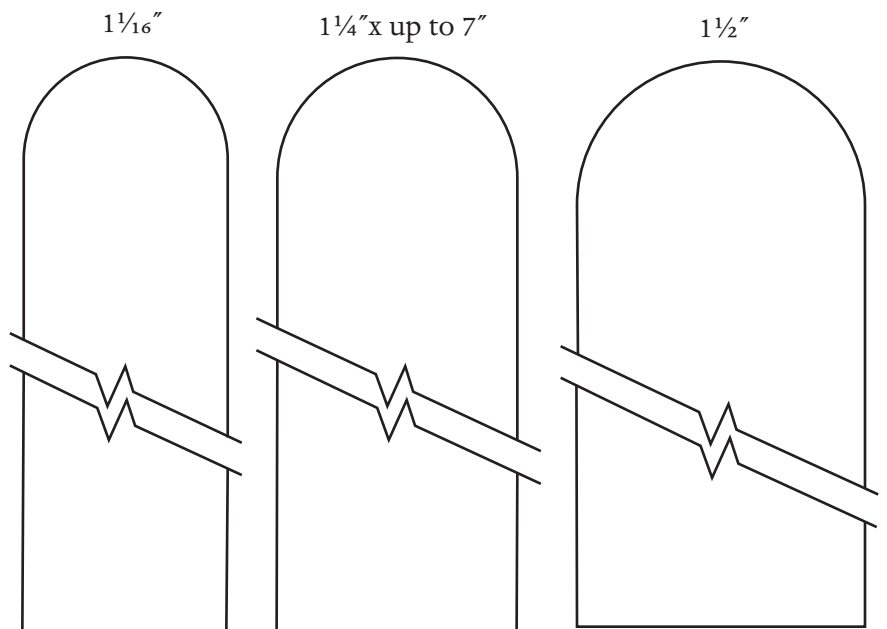
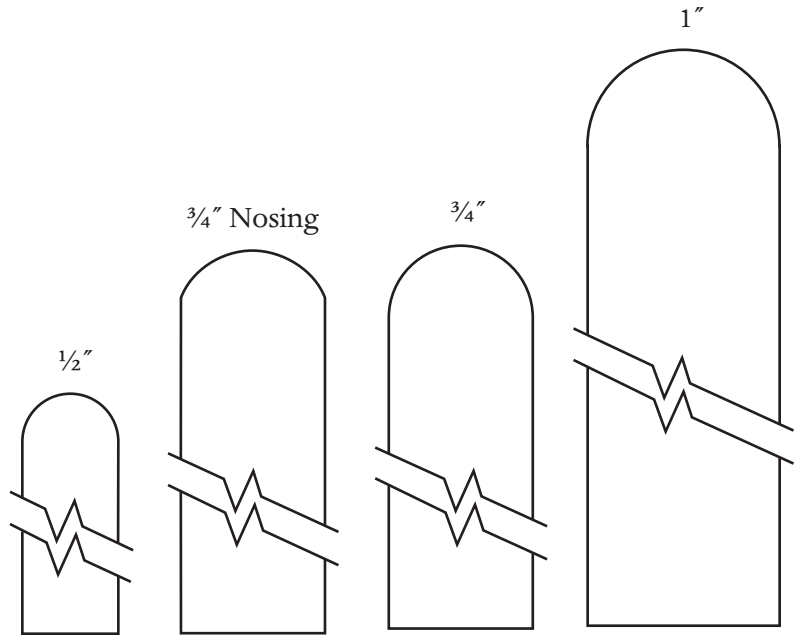

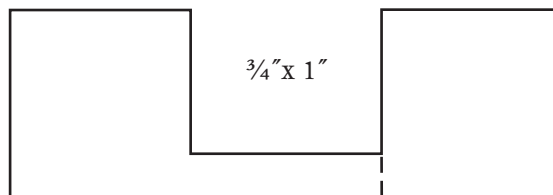
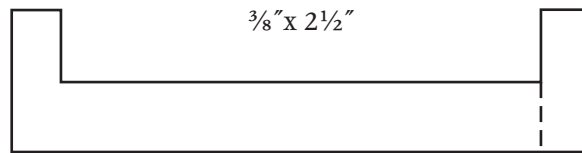
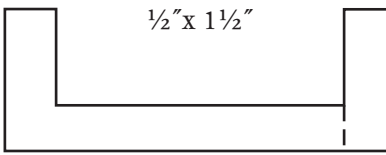
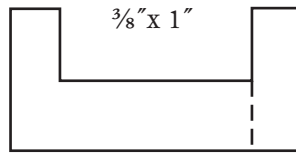
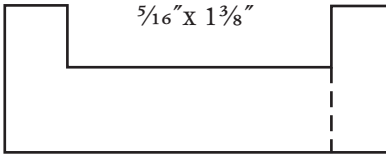
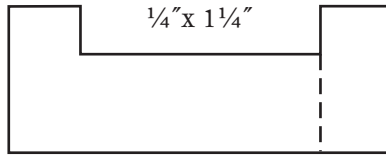

1/2" x 1 1/2" Reducer

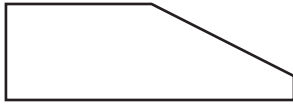

PJ706

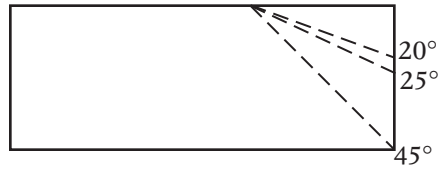

Custom Angles

(specify board size, position and angle of cut desired)

1/2" x 2" Reducer



PJ705

3/4" x 2" Reducer

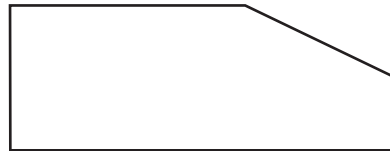

45° Angle

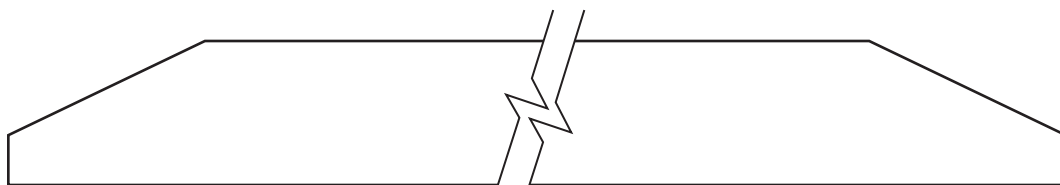

Threshold

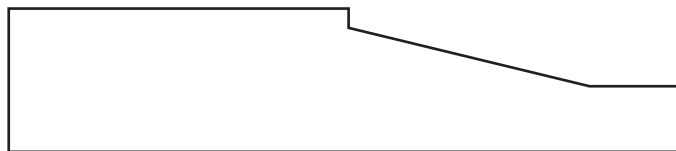

PJ701



PJ704

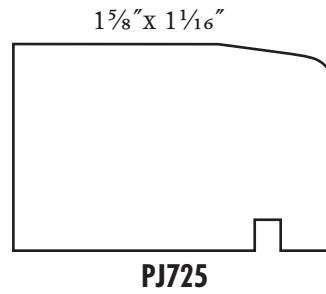
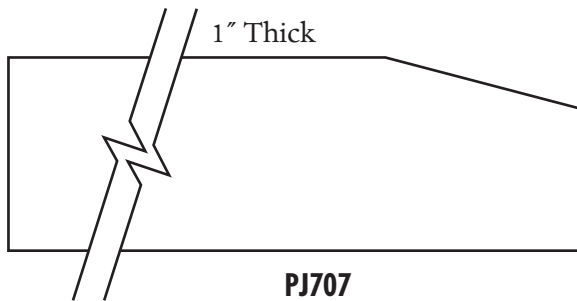
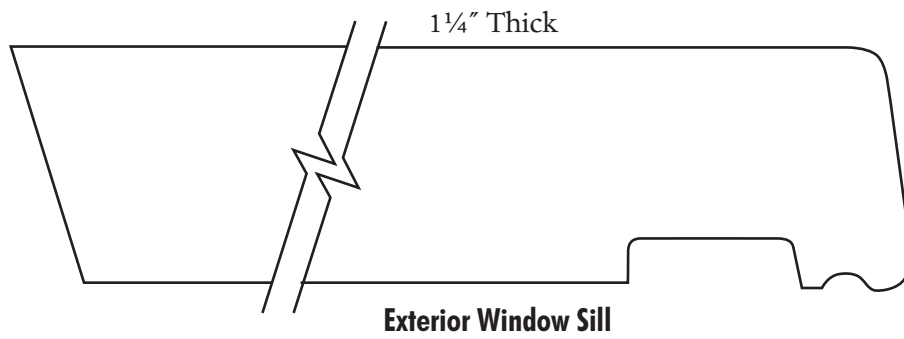

Stoolcap fits Marvin Integrity 6 9/16 JB

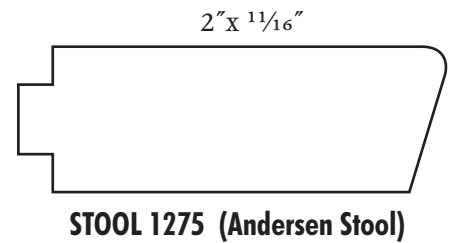
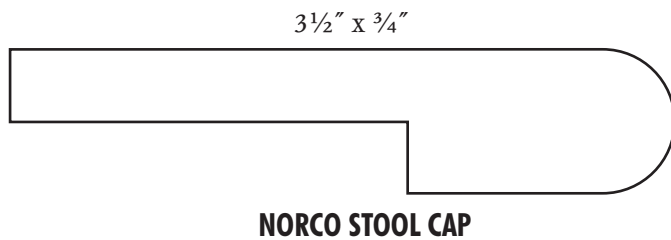
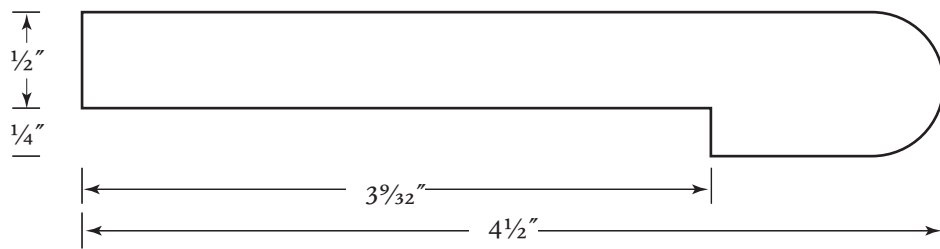

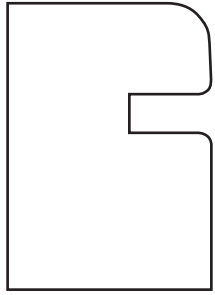

PJ703 Screen Stock

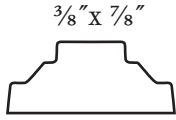

PJ702 (NORCO Grill)

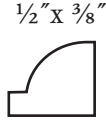

PJ734

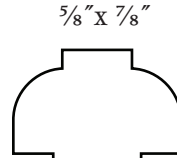

PJ741

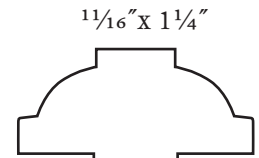

PJ742

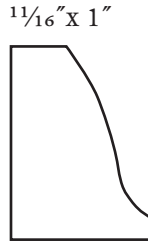

PJ713

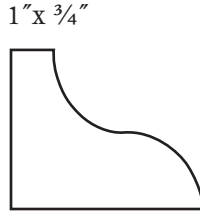

PJ708

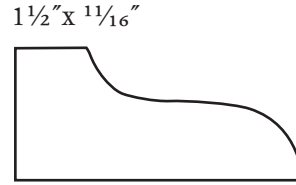

PJ709

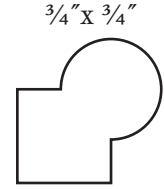

PJ738
(pencil moulding)

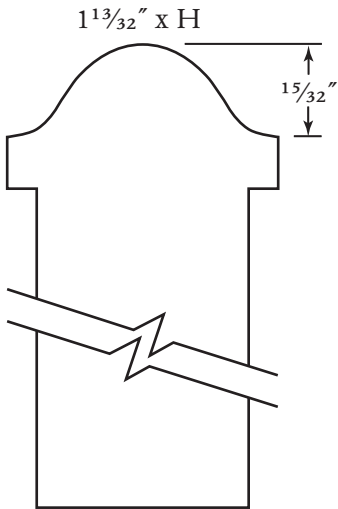

PJ746

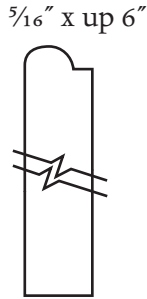

PJ729

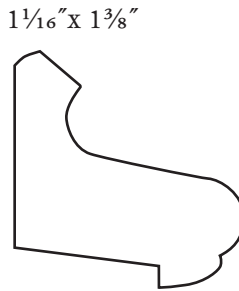

PJ732

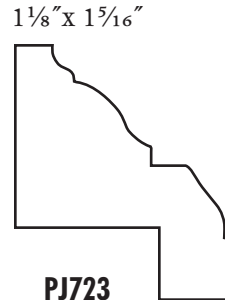

PJ723

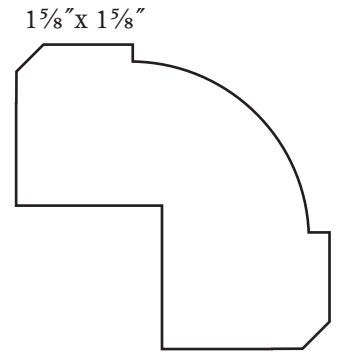

PJ745
(required 7/8" router bit)



PJ720

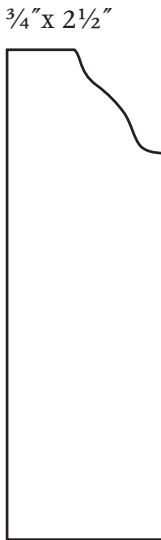

PJ712

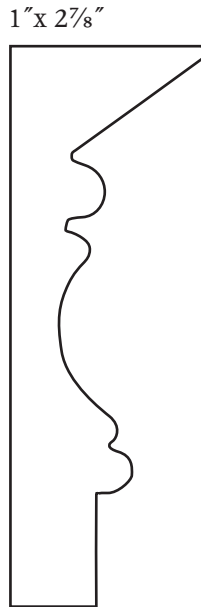

PJ722

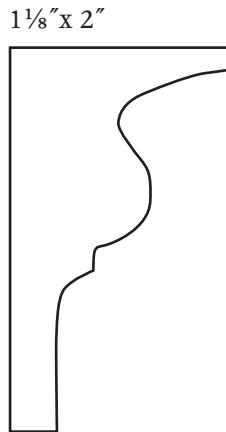

PJ721

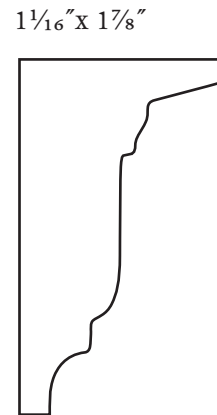

PJ710

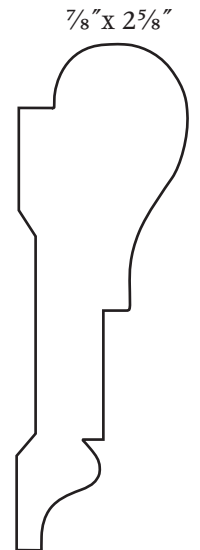

PJ717

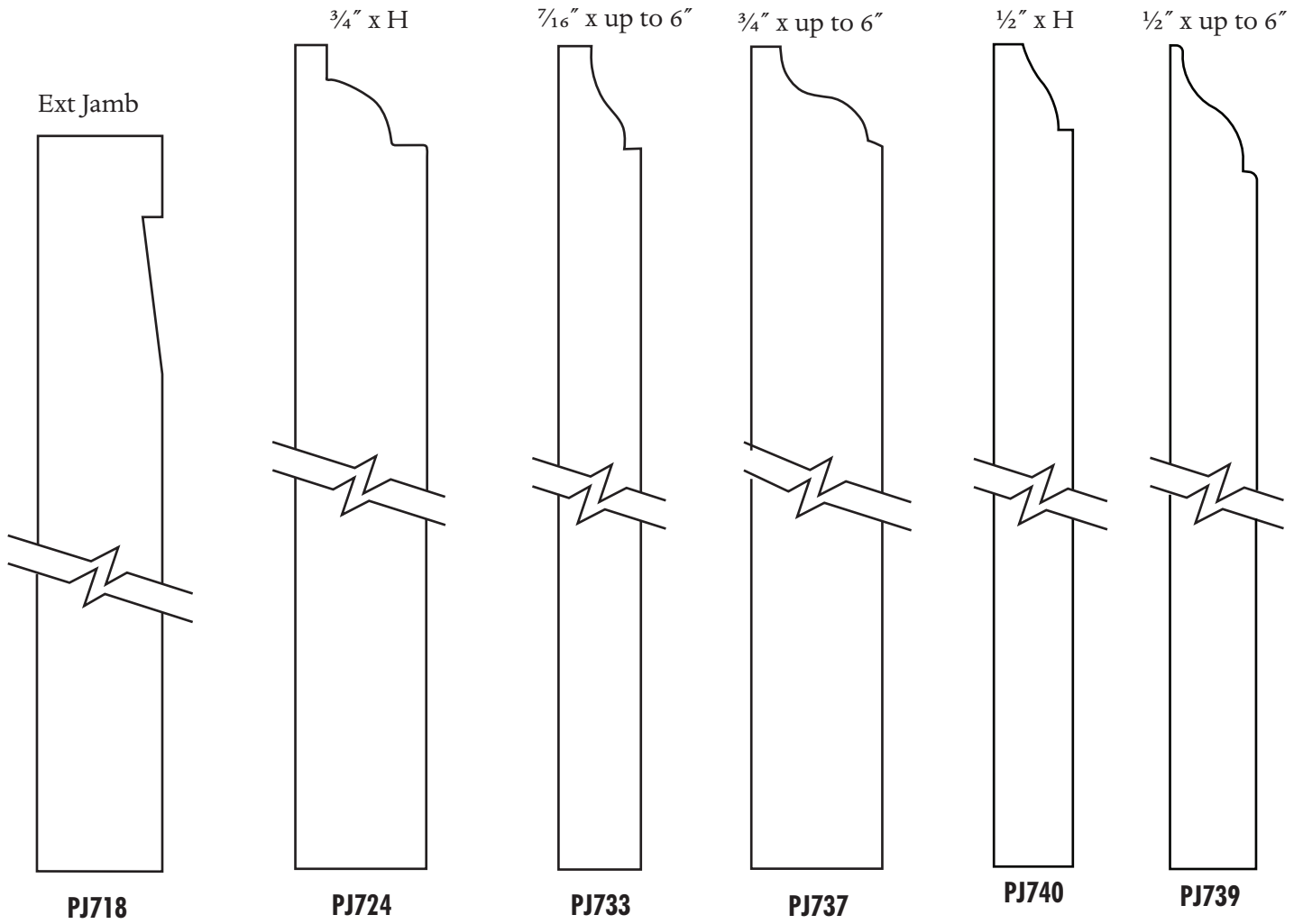

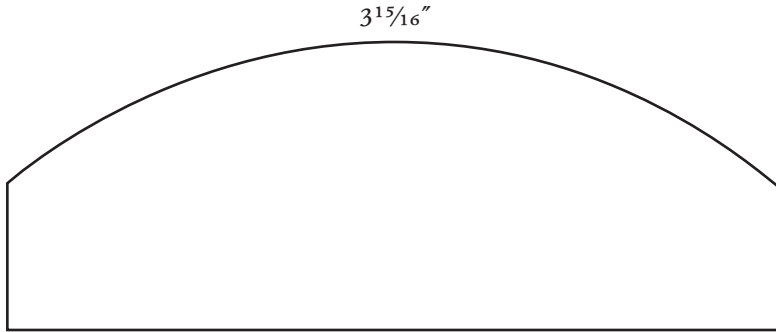

PJ716

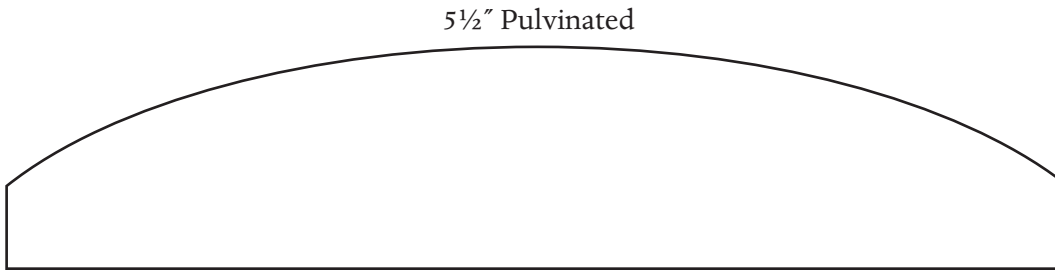

PJ711

$1\frac{1}{16}'' \times 2\frac{1}{8}''$

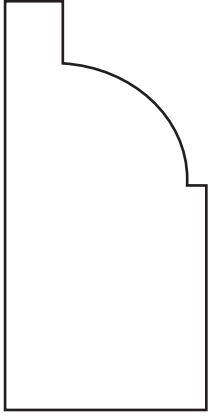

PJ744

$1\frac{1}{2}'' \times 2\frac{3}{4}''$

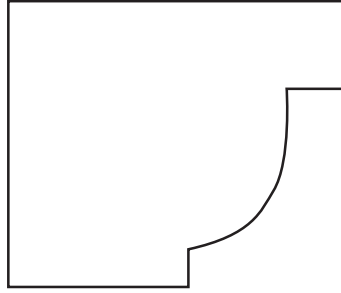

PJ748

$1\frac{5}{16}'' \times \frac{5}{8}''$



PJ743

$\frac{5}{8}'' \times \frac{7}{8}''$

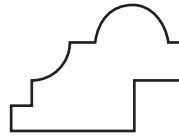

PJ747

$\frac{3}{8}'' \times \frac{3}{4}''$



PJ753

$1\frac{3}{16}'' \times 4\frac{1}{8}''$

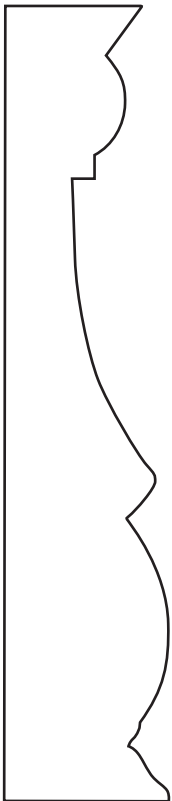

PJ749

$\frac{3}{4}'' \times 4\frac{7}{8}''$

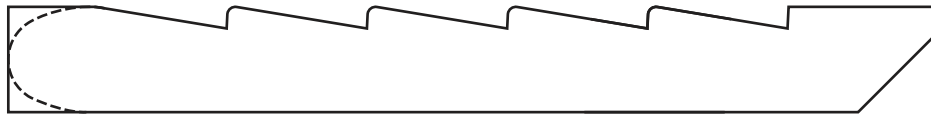

PJ750 Birdhouse Roof

